

Snopake[®] | brands

Snopake[®]  **Swordfish**  **Platignum**



Love Stationery. Love Snopake.

2021 Catalogue

Snopake® | since 1955



because to err is human



Welcome to the *Snopake*® brands 2021 catalogue

Our History

Our roots go back over 65 years to 1955, when Snopake, one of the world's first correction fluids, was introduced by the Battelle Institute of America. In 1988, we developed the first, hard wearing polypropylene filing product to the stationery market and Snopake Ltd was born. This was successfully followed in 2005 by Swordfish, a range of high quality but affordable Paper Shredders, Paper Trimmers, Pencil Sharpeners, Laminators and, more recently, Electrical Accessories.

Over 100 years of Platignum

2020 marked over 100 years of Platignum. Starting in 1919 as Platignum Pen Co. the world of pens changed with the self-filing gold plated nib fountain pen. Platignum then created the retractable ballpoint in 1950 and has continued its innovative streak with a range of ball point and fountain pens.

Over 100 years on, Platignum continues to write the history of the pen.

Today

From our Head Office in London, and distribution centre in Suffolk, we market our products in over 70 countries. We believe in excellence and practise a continual process of improvement and innovation. Our business is built on integrity. We follow clear ethical guidelines and strictly enforce them throughout the company. Our culture is defined by an entrepreneurial spirit that is pervasive and global. We encourage our people to make an impact, to take action and responsibility.

Our Products

We are passionate about our products; we thrive on superior product innovation and never compromise on quality. Our products are backed by guarantee and have been manufactured to the highest standards so that they remain cost effective purchases over the longer term.

Sustainability

Snopake Brands recognises its responsibility to conduct business in a way that protects the environment. We believe we have an important duty to ensure good environmental performance in all our business operations and to provide the necessary organisation, commitment and training to fulfil this obligation. The management firmly believes in, and is committed to, monitoring and improving environmental performance, pollution prevention and environmental protection.

At Snopake we never compromise on quality and have you, our customer, to thank for the success of this Company. If however, you haven't chosen a Snopake Brands product previously, try us - put us to the test.

Ronald.J.H.Stern
Director

Snopake®

About Snopake	06
Product Information	07
Colours & Finishes	08
Snopake Icons	09

CORRECTION	10-11
------------	-------

NOTES & TABS	12-16
--------------	-------

ADHESIVES	17-20
-----------	-------

ZIPPA-BAGS	21-26
------------	-------

FILING & STORAGE	27-34
------------------	-------

POLYFILES	35-42
-----------	-------

NOTEBOOKS & DISPLAY BOOKS	43-47
---------------------------	-------

RINGBINDERS	48-52
-------------	-------

RINGBINDER ACCESSORIES	53-56
------------------------	-------

EXPANDING FILES & ORGANISERS	57-63
------------------------------	-------

PLEASE NOTE: All information, descriptions and specifications are believed to be correct as of December 2020 but due to our policy of continued development, may be subject to change without notice.

Swordfish

About Swordfish	65
-----------------	----

The Colours of Swordfish	66
--------------------------	----

PAPER SHREDDERS	67-77
-----------------	-------

LAMINATORS	78-85
------------	-------

PENCIL SHARPENERS & ERASERS	86-98
-----------------------------	-------

PAPER TRIMMERS	99-102
----------------	--------

PRECISION CUTTING	103
-------------------	-----

ELECTRICAL ACCESSORIES	104-106
------------------------	---------

SPECIFICATION GRIDS	107-122
---------------------	---------

Platignum LONDON 1919

Platignum History	124
-------------------	-----

S-TIXX	125
--------	-----

TIXX	126-129
------	---------

CARNABY STREET	130
----------------	-----

NO.9	131
------	-----

VIBE	132
------	-----

STUDIO	133-134
--------	---------

REFILLS	135
---------	-----

POINT-OF-SALE	136
---------------	-----

Index	137-142
-------	---------

Support Information	143
---------------------	-----

Snpake®



What makes a Snopake product stand out from the crowd?

Six decades down the line, Snopake products are recognised as the market leader in polypropylene filing, storage and presentation products and clearly lead the way in the office product sector.

The brand's main product focus is to develop high quality, functional, affordable but trusted products for everyday use. The Snopake portfolio ranges from desk-top essentials such as sticky notes, glue and correction through to display books, ringbinders and filing & storage products.

Today, with the age of technology, one wonders whether correction products are still required but, in fact, our correction products are still used for correcting hand-written mistakes in the office, at school or at home.

Each product is meticulously created, details such as extra strength, durability of the product, unique Snopake features, such as closures and indexing, are thought through at every stage of the development process. We listen to our customers, because it's important, but also because we want our customers to enjoy the Snopake experience.

Because we truly believe in our products, each filing or storage product has a product promise guarantee of between 2 to 10 years. Before going to market, each Snopake product must pass the 5 Step Fitness Test to ensure they are not only fit for purpose but, most importantly, last longer than their product promise guarantee. Each product is tested for strength, durability, usability, affordability and sustainability before it is deemed fit for purpose and awarded the Snopake product promise guarantee.

Our best selling product is the Snopake Polyfile. Launched in 1995 as an alternative to the manila folder, our data shows that a Polyfile is sold every 6 seconds somewhere in the world. Available in sizes from DL, A5, A4, Foolscap and A3, the Polyfile comes in Clear, Classic, Electra, Fusion and more recently in Rainbow colours. Featuring a press stud closure to keep contents secure, and a handy indexing system unique to Snopake, each Polyfile carries a product promise guarantee of 5 years!

Snopake celebrate over 60 years of dedication, pride, perfection and success. We hope you'll join us as we continue our journey, our continued commitment to quality, our dedication to innovation but, above all, our commitment to you, our customers.



Product Information

ENVIRONMENTAL TERMS

Biodegradable

Biodegradable materials are capable of being decomposed by natural processes. The ability of a material to biodegrade depends largely upon its molecular structure. When disposed of, some materials degrade in only a few weeks, while others take several months or even years.

Recycled

Recycled materials have already been used before and renewed for further use. At Snopake, we only ever describe products as recycled if a significant proportion of the material has been used before.

Recyclable

Recycling is the process of converting waste materials into new materials and objects. It is an alternative to waste disposal that can save material and help lower greenhouse gas emissions. Recycling can prevent the waste of potentially useful materials and reduce the consumption of fresh raw materials, thereby reducing: energy usage, air pollution and water pollution.

At Snopake we only ever describe products as recyclable if a significant proportion of the material is recyclable.



MATERIALS

PP

Polypropylene is made from propylene and ethylene – two waste products of the oil and gas industry. Until the invention of polypropylene, these waste products were simply burnt as they had no commercial value. Today, polypropylene is one of the most widely used plastics in the world it is robust, extremely durable, water resistant and recyclable.

LDPE

Low density polyethylene is a lightweight thermoplastic made from the monomer ethylene. Flexible, moisture-resistant and recyclable.

EVA

Ethylene vinyl acetate is the copolymer of ethylene and vinyl acetate. It's an extremely elastic material that produces materials which are rubber-like in softness and, yet with excellent toughness and flexibility. The porous elastomeric material is three times as flexible as low-density polyethylene and is a recyclable material.

EPPE

EPPE means **EVA+PE+MPE**. It is one of the synthetic polymer chemical materials that are between PE and EVA material. EPPE has a high transparency, high softness and toughness and a low temperature resistant (-50 degree). It is non toxic, phthalate free, pollution-free and a recyclable material.

FSC®

All our paper products carry the FSC® logo to show that their materials came from sustainable forests.



Colours & Finishes

Electra Polypropylene

The Snopake signature colour range that includes stunning green, turquoise, purple, pink and blue colours.



Classic Polypropylene

A popular and timeless range of more subtle colours including blue, yellow, green, red and clear.



Polka Dot Polypropylene

An exciting range of stunningly bright colours including pink, teal, blue, orange, purple, green, red and light yellow.



Fusion Polypropylene

An elegant range of fashion led colours including Burgundy, Smoke, Emerald, Indigo and Plum.



Neon Notes

A range of extremely bright or fluorescent colours, which can include yellow, green, pink, orange, blue and purple.



Superline Emboss

The majority of Snopake polypropylene products have a Superline emboss - this attractive finish has a professional look and feel.

Zeon Polypropylene

A collection of fabulous metallic black, blue, graphite, green and red colours.



Bright Polypropylene

A range of bright colours which include green, pink, purple, white and yellow.



Lite Polypropylene

A combination of unique light colours which include parchment, light blue, dark blue, pink and purple.



Rainbow

A wonderful combination of striking colours which include blue, orange, green, red, purple and yellow.



Frost Emboss

A frost emboss is ideal for regularly handled products as it is smooth to the touch, providing added comfort.

A-Z of Product Icons



Unique Snopake guarantee



Smooth action plastic 'zip' top closure



The thickness of material in millimetres



The capacity of the product



Holds standard 54 x 86mm business or ID cards



Holds standard CDs or DVDs



The volume of usable product in millilitres



Indicates a gusseted design to allow for expansion and greater capacity



Includes a label which can be written on for personalisation



The length of usable product in metres



Mechanism holds un-punched filing and documents in place



Multiple pockets gusseted to allow for expansion and greater capacity



The maximum number of sheets of 80gsm paper that a product will comfortably hold



Features a built-in pen holder for convenience



'O' Ring binding mechanisms are circular in shape and attached to the spine



The number of sheets or notes included with a particular product



Can be used for organising and indexing documents



'D' Ring binding mechanisms are fitted to the back cover, allowing papers to sit perfectly straight



The number of index tabs included with a particular product



Write-on label on spine for personalisation and titles



The product is A3 and can fold to A4



Can be easily removed but retains stickiness to be repositioned



Allows you to insert your own leaflet or design to appear as the front cover



Features a strong hanging loop



Can be easily seen through, allowing contents to be visible



Portrait shaped products with a top opening to allow easy and instant retrieval of documents from a backpack



Made from an environmentally heavy duty material and designed to last



The weight of usable product in grams



Enables documents to be filed without the need for punching holes



Product measures at 300mm x 300mm (13 x 13")



Washes out at 30 degrees



Sticky label to personalise organiser tabs



Allows for better organisation of items and documents whilst travelling



This is suitable for children over 36 months



Includes an inside pocket for loose papers and notes



Seams are double-welded for ultimate strength and security



Strong metal 'zip-pull' side closure



Ideal for personalisation and visibility of internal documents

CORRECTION

Snopake has been correcting mistakes since 1955 - In fact, we were one of the world's first correction fluids! Originally used for correcting typing mistakes, today our correction products are mainly used to cover handwriting mistakes. Available in fluid, pen or roller, Snopake correction has the correct solution for your needs - whether they be large or small!





20ml

VOLUME



7ml

VOLUME

Hi-Tech Correction Fluid

- Suitable for use on virtually all surfaces, covering most everyday inks, laser print, inkjet text, faxes and photocopies
- Trichloroethane-free
- Unique quick-drying formula

CODE	DESCRIPTION	TRADE PK	OUTER
13139	Correction Fluid 20ml • Bottle • White	10 Bottles	24 Packs
15836	Correction Fluid 20ml • Blistercard • White	10 B/Cards of 2 Bottles	12 Packs

PinPointST Correction Pen

- Extra-fast drying fluid for rapid, accurate corrections
- PinPointST features a stainless steel tip for extra smooth application
- Improved fluid formula for better covering power
- Creates an even surface which allows you to re-write easily

CODE	DESCRIPTION	TRADE PK	OUTER
13078	7ml • PinPoint ST • Display Box • White	12 Pens	12 Packs
15835	7ml • PinPoint ST • Blistercard • White	12 B/Cards of 2 Pens	12 Packs



5

METER

U Name It Correction Roller

- Unique write-on label for a name, department or location
- Radiused thumb grip and rubber finger pad guarantee maximum accuracy and comfort
- Tape covers mistakes instantly and is immediately ready for re-writing

CODE	DESCRIPTION	TRADE PK	OUTER
13434	5mm x 5m • Mini Blistercard • White	10 Blistercards	10 Packs

Sndpake® RECOMMENDS



8.5

METER

Slider Correction Roller

- 5mm wide tape 8.5metres in length
- Slide close to protect tape
- Guarantee maximum accuracy and comfort
- Ultra-smooth dry white tape covers mistakes instantly
- Tape is immediately ready for re-writing
- Available in attractive Euro hook blister card retail pack

CODE	DESCRIPTION	TRADE PK	OUTER
15748	Slider Correction Roller • Blistercard	12 Blistercards	24 Packs

NOTES & TABS

Snopake Notes and Tabs are a must have in the home, school or workplace. From leaving reminders on desks or around the home, it's always useful to have a pad of Snopake Sticky Notes to hand.

Each Sticky Note is produced to Snopake's highest standard, ensuring you get the best possible product. Our Sticky Notes can be easily removed whilst retaining their stickiness, so you can reposition them over and over again.

Our brightly coloured Index Tabs are also an essential accessory, from highlighting text to revision page marking to emphasising those small yet important notes, our range of Index Tabs are handy to all.





Index Tab Arrow Highlighters

- Arrow head allows precise highlighting – ideal for maps and technical drawings
- Film highlighters double up as page markers
- Transparent material shows the print below
- Writeable surface for notes

CODE	DESCRIPTION	TRADE PK	OUTER
13906	44 x 12mm • 125 tabs • Neon Assorted	12 Blistercards	12 Packs

Neon Assorted - 25 x Pink, 25 x Yellow, 25 x Orange, 25 x Green, 25 x Blue

Index Tab Highlighters

- A film index tab that can also be used as a non-marking highlighter
- Ideal for use on original documentation, such as contracts and library books, where a traditional (marking) highlighter cannot be used
- Longer-lasting, smarter appearance than everyday paper versions
- Writeable surface

CODE	DESCRIPTION	TRADE PK	OUTER
13154	45 x 12mm • 125 tabs • Neon Assorted	12 Blistercards	12 Packs

Neon Assorted - 25 x Pink, 25 x Yellow, 25 x Orange, 25 x Green, 25 x Blue



Index Tab Pagemarkers

- Printed paper strips with colour-coded tips
- Handy for indexing or page marking
- Ensure that you never lose your place again
- Easily removed and retains stickiness for repositioning

CODE	DESCRIPTION	TRADE PK	OUTER
13150	50 x 12mm • 250 tabs • White with Assorted Tips	12 Blistercards	12 Packs

Assorted - 50 x Red, 50 x Yellow, 50 x Orange, 50 x Green, 50 x Blue

Index Tab Highlighters

- A film index tab that can also be used as a non-marking highlighter
- Ideal for use on original documentation, such as contracts and library books, where a traditional (marking) highlighter cannot be used
- Longer-lasting, smarter appearance than everyday paper versions
- Writeable surface

CODE	DESCRIPTION	TRADE PK	OUTER
15846	45 x 8mm • 160 Tabs • Neon Assorted	12 B/Cards	12 Packs

Neon Assorted - 20 x Teal, 20 x Green, 20 x Yellow, 20 x Pink, 20 x Fuschia, 20 x Orange, 20 x Purple, 20 x Blue



Filing Index Tabs

- Semi transparent index tab with colour-coded tips
- Extra thick 100µm PET material, strong & durable
- Handy for indexing or page marking
- Easily removed & retains stickiness for repositioning

CODE	DESCRIPTION	TRADE PK	OUTER
15882	38 x 23mm • 80 tabs • Assorted	12 Blistercards	12 Packs

Assorted - 20 x Red, 20 x Yellow, 20 x Blue, 20 x Green



Filing Index Tabs

- Semi transparent index tab with colour-coded tips
- Extra thick 100µm PET material, strong & durable
- Handy for indexing or page marking
- Easily removed & retains stickiness for repositioning

CODE	DESCRIPTION	TRADE PK	OUTER
15883	38 x 51mm • 24 tabs • Assorted	12 Blistercards	12 Packs

Assorted - 6 x Red, 6 x Yellow, 6 x Blue, 6 x Green



Filing Index Tabs

- Semi transparent index tab with colour-coded tips
- Extra thick 100µm PET material, strong & durable
- Handy for indexing or page marking
- Easily removed & retains stickiness for repositioning

CODE	DESCRIPTION	TRADE PK	OUTER
15884	38 x 76mm • 24 tabs • Assorted (B)	12 Blistercards	12 Packs

Assorted - 6 x Red, 6 x Yellow, 6 x Blue, 6 x Green



Filing Index Tabs with Ruler

- Semi transparent index tab with colour-coded tips
- Extra thick 100µm PET material, strong & durable
- Attached to a useful 15cm ruler
- Handy for indexing or page marking
- Easily removed & retains stickiness for repositioning

CODE	DESCRIPTION	TRADE PK	OUTER
15885	37 x 50mm • 30 tabs • Assorted	12 Blistercards	12 Packs

Assorted - 10 x Blue, 10 x Yellow, 10 x Green



15845



15844



Index Tab PageMarkers

- A film index tab with colour-coded tips
- Handy for indexing or page marking
- Ensure you never lose your place again
- Easily removed & retains stickiness for repositioning

CODE	DESCRIPTION	TRADE PK	OUTER
15844	45 x 12mm • 100 Tabs • Assorted (A)	12 B/Cards	12 Packs
15845	45 x 8mm • 160 Tabs • Assorted (B)	12 B/Cards	12 Packs

Assorted (A) - 20 x Teal, 20 x Green, 20 x Yellow, 20 x Orange, 20 x Red

Assorted (B) - 20 x Blue, 20 x Pink, 20 x Purple, 20 x Teal, 20 x Green, 20 x Yellow, 20 x Orange, 20 x Red

Sticky Notes

- Bright Neon notes to help get your messages noticed instantly
- Easily removed, leaving no residue yet retaining stickiness for repositioning
- Available in a fantastic, compact counter display box

CODE	DESCRIPTION	TRADE PK	OUTER
14007	76 x 50mm (3x2") • 100 Sheets • Neon Assorted	30 Pads	12 Packs

Neon Assorted - 10 x Yellow, 10 x Pink, 10 x Orange

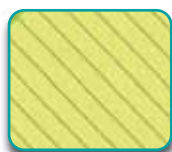

150 x 101mm



76 x 76mm
76 x 24mm



45 x 12mm



Lined Pad

- Assorted Neon and Pastel pads
- Lines to help organise notes easily
- Easily removed, leaving no residue yet retaining stickiness for repositioning

CODE	DESCRIPTION	TRADE PK	OUTER
15840	150 x 101mm • Pastel Yellow	1 Pad	60 Packs
15841	150 x 101mm • Neon Yellow	1 Pad	60 Packs
15842	150 x 101mm • Neon Green	1 Pad	60 Packs
15843	150 x 101mm • Neon Magenta	1 Pad	60 Packs

Desk Memo Set

- Contains 2 x Neon Sticky Notes and 5 x index highlighters
- Plastic tray with pen holder and storage tray to organise your desk
- Easily removed, leaving no residue yet retaining stickiness for repositioning

CODE	DESCRIPTION	TRADE PK	OUTER
15848	Assorted	1 Pack	40 Packs

Sticky Notes – Neon Yellow and Green

Index Tabs – 20 x Orange, 20 x Pink, 20 x Yellow, 20 x Green, 20 x Blue



- x450
NUMBER OF SHEETS
- REPOSITIONABLE
- FSC
www.fsc.org
FSC® C122585



- x100
NUMBER OF SHEETS
- REPOSITIONABLE
- FSC
www.fsc.org
FSC® C122585

Rainbow NeonMix Sticky Notes

- Assorted neon and rainbow cubes
- Easily removed, leaving no residue yet retaining stickiness for repositioning

CODE	DESCRIPTION	TRADE PK	OUTER
15847	76 x 76mm (3 x 3") • 450 Sheets* • Blue Rainbow	1 Cube	72 Packs
15759	76 x 76mm (3 x 3") • 450 Sheets* • Pink Rainbow	1 Cube	72 Packs
15760	76 x 76mm (3 x 3") • 450 Sheets* • Green Rainbow	1 Cube	72 Packs
15761	76 x 76mm (3 x 3") • 450 Sheets* • Multicoloured Rainbow	1 Cube	72 Packs

*No of sheets per pad

Yellow Sticky Notes

- Ever popular sticky notes produced to Snopake's high standard
- Stick firmly to almost any surface
- Easily removed, leaving no residue yet retaining stickiness for repositioning

CODE	DESCRIPTION	TRADE PK	OUTER
12127	50 x 38mm (1½ x 2") • 100 Sheets* • Yellow	12 Pads	72 Packs
12128	76 x 76mm (3 x 3") • 100 Sheets* • Yellow	12 Pads	36 Packs
12133	127 x 76mm (5 x 3") • 100 Sheets* • Yellow	12 Pads	24 Packs

*No of sheets per pad



- x100
NUMBER OF SHEETS
76 x 76mm
127 x 76mm
- x400
NUMBER OF SHEETS
50 x 50mm
- x450
NUMBER OF SHEETS
76 x 76mm
- REPOSITIONABLE
- FSC
www.fsc.org
FSC® C122585

Neon Sticky Notes

- Extra bright neon notes to help get your messages noticed instantly
- Assorted Neon colour packs
- Easily removed, leaving no residue yet retaining stickiness for repositioning

CODE	DESCRIPTION	TRADE PK	OUTER
13223	50 x 50mm (2 x 2") • 400 Sheets* • Neon Assorted (A)	1 Cube	144 Packs
11702	76 x 76mm (3 x 3") • 450 Sheets* • Neon Assorted (A)	1 Cube	108 Packs
13527	76 x 76mm (3 x 3") • 100 Sheets* • Neon Assorted (B)	6 Pads	30 Packs
13528	127 x 76mm (5 x 3") • 100 Sheets* • Neon Assorted (B)	6 Pads	20 Packs

Neon Assorted (A) - 1 x Yellow, 1 x Orange, 1 x Pink, 1 x Blue and 1 x Green
Neon Assorted (B) - 2 x Yellow, 1 x Orange, 2 x Pink and 1 x Green

*No of sheets per pad



- x60
NUMBER OF SHEETS
51 x 88mm
- x90
NUMBER OF SHEETS
25 x 88mm
- REPOSITIONABLE
- FSC
www.fsc.org
FSC® C122585

Removable Sticky Labels

- Sticky across entire label
- Non-marking and easily removable
- Sticks on plastic, cardboard, glass, paper and many more surfaces
- Perforated for easy application

CODE	DESCRIPTION	TRADE PK	OUTER
15789	25 x 88mm (1 x 3.5") • 90 Sheets* • Pastel Assorted (A)	12 Pads	24 Packs
15790	25 x 88mm (1 x 3.5") • 90 Sheets* • Neon Assorted (B)	12 Pads	24 Packs
15791	51 x 88mm (2 x 3.5") • 60 Sheets* • Pastel Assorted (C)	12 Pads	24 Packs
15792	51 x 88mm (2 x 3.5") • 60 Sheets* • Neon Assorted (D)	12 Pads	24 Packs

Pastel Assorted (A) - 1 x Green, 1 x Yellow and 1 x Orange

Neon Assorted (B) - 1 x Green, 1 x Yellow and 1 x Magenta

Pastel Assorted (C) - 1 x Yellow and 1 x Orange

Neon Assorted (D) - 1 x Magenta and 1 x Yellow

*No of sheets per pad

ADHESIVES

Available in 9g to 36g size, you will never come unstuck using Snopake GlueSticks. Not only is the glue in our GlueSticks washable and suitable for children, the TwinTip Glue has a broad tip for covering large areas. Our new 'Super Sticky' Glue allows you to be as creative as you want and is ideal for sticking soft fabrics, glitter, canvas and all sorts of projects in the home, office or at school.



Snpake® RECOMMENDS



Super Sticky Glue

- Solid white and washable adhesive
- Sticks paper, card, photos, felt and other materials
- Shelf life of 2 years



CODE	DESCRIPTION	TRADE PK	OUTER
15724	21g • Display Box of 12 • White	12 Sticks	24 Packs
15754	36g • Display Box of 12 • White	12 Sticks	24 Packs



IDEAL FOR SCHOOLS

PVP GlueStick

- Solid, white, non-toxic & washable adhesive
- Washable at 40° C
- Safe for children over 36 months
- Shelf life of 2 years



CODE	DESCRIPTION	TRADE PK	OUTER
15797	9g • Display of 30 • White	30 Sticks	36 Packs
15798	15g • Display of 20 • White	20 Sticks	24 Packs
15799	21g • Display of 20 • White	20 Sticks	24 Packs
15800	36g • Display of 12 • White	12 Sticks	24 Packs
15829	Jumbo 100g • Display of 12 • White	12 Sticks	1 Pack

PLEASE NOTE: Other class and bulk packs available - please ask for details

PLEASE NOTE: Most of our adhesives have a shelf life of 24 months (if stored as packaged and must not be stored near heat or in direct sunlight)

MegaStick GlueStick

- Not for outdoor use, keep away from damp
- Ideal for sticking absorbent materials like wood, fabric, paper/card, leather and non-absorbent material like glass, ceramic, metal, plastic as well as Porous to Porous materials
- Sticking time - initial bonding time 30mins, complete curing in 24hrs
- Supreme strength



CODE	DESCRIPTION	TRADE PK	OUTER
15820	21g • Display Box of 12	12 Sticks	8 Packs
15821	36g • Display Box of 12	12 Sticks	8 Packs



TwinTip Glue

- A unique 2-in-1 clear glue applicator
- Fine tip at one end for precision gluing
- Broad tip at other end for covering larger areas
- Ever-popular clear glue sticks paper and card



CODE	DESCRIPTION	TRADE PK	OUTER
13912	42ml • Display Box of 12 • Clear	12 Bottles	24 Packs





Super Blue GlueStick

- PVP glue stick
- Sticks paper, card, photos and other materials
- Applies blue to show where you glued and then dries clear



CODE	DESCRIPTION	TRADE PK	OUTER
15824	21g • Display Box of 20 • Blue	20 Sticks	24 Packs
15825	36g • Display Box of 20 • Blue	12 Sticks	24 Packs



PLEASE NOTE: Most of our adhesives have a shelf life of 24 months (if stored as packaged and must not be stored near heat or in direct sunlight)



ZIPPA-BAGS

Snopake Zippa-Bags are tough, durable and water resistant making them the ideal storage solution for frequent use in the most challenging of environments.

From storing papers, pencils and craft objects to even using them for packing wet swimsuits, personal objects in suitcases or multiple uses within the home, there is a Zippa-Bag available in a variety of colours or sizes to suit your every need.

Snopake's Zippa-Bags are made from durable, flexible and water-resistant material to ensure each Zippa-Bag secures and protects your belongings.





Zippa-Bag

- With smooth action, top opening, plastic zip pull
- Colour matched with smart graphics
- Different colour 'zip strips' for easy identification
- Transparent, flexible material



CODE	DESCRIPTION	TRADE PK	OUTER
11448	A5 (250 x 180mm) Zippa-Bag • Assorted	25 Bags	10 Packs
11463	A4 Plus (355 x 235mm) Zippa-Bag • Assorted	25 Bags	10 Packs

Assorted - 10 x Blue, 5 x Red, 5 x Yellow, 5 x Green



Zippa-Bag 'S' Electra

- Strong, long-lasting metal zip pull on side
- Available in popular Electra colour range
- Features a 'write-on' panel at front for content identification
- Versatile, tough and very practical around the home and office



CODE	DESCRIPTION	TRADE PK	OUTER
14129	DL (240 x 130mm) Zippa-Bag 'S' • Electra Assorted	25 Bags	32 Packs
14135	A5 (250 x 180mm) Zippa-Bag 'S' • Electra Assorted	25 Bags	32 Packs
14141	A4 (325 x 235mm) Zippa-Bag 'S' • Electra Assorted	25 Bags	24 Packs

Electra Assorted - 5 x Blue, 5 x Green, 5 x Purple, 5 x Pink, 5 x Turquoise

GUIDE



Snopake Zippa-Bags are manufactured from polyethylene which is more commonly known as LDPE. Polyethylene is durable and water resistant making Snopake Zippa-Bags suitable for frequent use in the most challenging environments.

Zippa-Bag 'S' Classic

- Ideal for filing, storage and presentation
- Heavy duty, long-lasting metal zip pull on side
- Different colour 'zip strips' for easy identification
- Features a 'write-on' panel at front for content identification
- Transparent, flexible material

CODE	DESCRIPTION	TRADE PK	OUTER
12687	A5 (250 x 180mm) Zippa-Bag 'S' • Blue	25 Bags	32 Packs
12692	A5 (250 x 180mm) Zippa-Bag 'S' • Red	25 Bags	32 Packs
12722	A5 (250 x 180mm) Zippa-Bag 'S' • Assorted	25 Bags	32 Packs
12736	A4 (325 x 235mm) Zippa-Bag 'S' • Blue	25 Bags	24 Packs
12796	A4 (325 x 235mm) Zippa-Bag 'S' • Assorted	25 Bags	24 Packs
12804	A4 Plus (370 x 260mm) Zippa-Bag 'S' • Blue	25 Bags	16 Packs
12805	A4 Plus (370 x 260mm) Zippa-Bag 'S' • Red	25 Bags	16 Packs
12806	A4 Plus (370 x 260mm) Zippa-Bag 'S' • Yellow	25 Bags	16 Packs
12814	A4 Plus (370 x 260mm) Zippa-Bag 'S' • Assorted	25 Bags	16 Packs
12821	A4 Plus Plus (405 x 260mm) Zippa-Bag 'S' • Assorted	25 Bags	16 Packs
12823	A3 (480 x 350mm) Zippa-Bag 'S' • Assorted	25 Bags	12 Packs

Assorted - 5 x Blue, 5 x Red, 5 x Yellow, 5 x Green, 5 x Orange

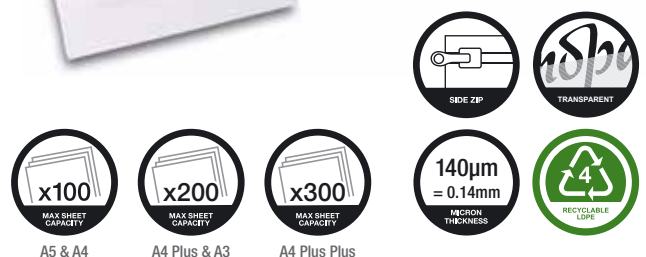

A5 & A4

A4 Plus & A3

A4 Plus Plus

Please note all measurements quoted are the internal measurements of the Zippa-Bag and not the external measurements.

EVA Mesh Zippa-Bag

- Size: DL, A5 & Foolscap in assorted colours
- Environmentally friendly, PVC free material which is water resistant & can be wiped clean
- Reinforced heavy duty 0.3mm mesh material ensures durability
- Heavy duty metal black zip with colour co-ordinated zip strip and hanging loop



CODE	DESCRIPTION	TRADE PK	OUTER
15817	DL (240 x 130mm) Mesh Bag • Assorted	3 Bags	80 Packs
15818	A5 (255 x 205mm) Mesh Bag • Assorted	3 Bags	80 Packs
15819	Foolscap (360 x 275mm) Mesh Bag • Assorted	3 Bags	70 Packs

Assorted - 1 x Red, Blue, Yellow

Sndspake® RECOMMENDS

EVA Mesh High Capacity Zippa-Bag

- Size: DL, A6, A5 & Foolscap in black
- Environmentally friendly, PVC free material which is water resistant & can be wiped clean
- Reinforced heavy duty 0.3mm mesh material ensures durability
- 40mm gusset provides extra capacity
- Heavy duty metal black zip with colour co-ordinated zip strip and hanging loop



CODE	DESCRIPTION	TRADE PK	OUTER
15856	A6 (150 x 120mm) Mesh Bag • Holds 250 Sheets • Black	3 Bags	80 Packs
15837	DL (240 x 130mm) Mesh Bag • Holds 400 Sheets • Black	3 Bags	80 Packs
15838	A5 (255 x 205mm) Mesh Bag • Holds 450 Sheets • Black	3 Bags	80 Packs
15839	Foolscap (360 x 275mm) Mesh Bag • Holds 600 Sheets • Black	3 Bags	70 Packs

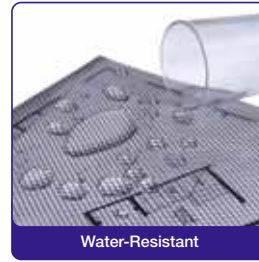

EVA Black Mesh High Capacity Zippa Bag

- Size: DL, A6, A5 & Foolscap in black
- Environmentally friendly, PVC free material which is water resistant & can be wiped clean
- Reinforced heavy duty 0.35mm mesh material ensures durability
- 40mm gusset provides extra capacity
- Heavy duty metal black zip with colour co-ordinated zip strip and hanging loop
- Business card holder on front



CODE	DESCRIPTION	TRADE PK	OUTER
15878	A6 (150 x 120mm) Mesh Bag • Black	3 Bags	80 Packs
15879	DL (240 x 130mm) Mesh Bag • Black	3 Bags	80 Packs
15880	A5 (255 x 205mm) Mesh Bag • Black	3 Bags	80 Packs
15881	Foolscap (362 x 275mm) Mesh Bag • Black	3 Bags	70 Packs

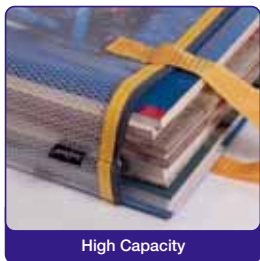

High Capacity



Flexible



Water-Resistant



Hook & Loop Handle



Hanging Loop



EVA Mesh High Capacity Project Zippa Bag

- Size: A4++ & A3 in assorted colours
- Environmentally friendly, PVC free material which is water resistant & can be wiped clean
- Reinforced heavy duty 0.35mm mesh material ensures durability
- 40mm gusset provides extra capacity
- Heavy duty metal grey zip with colour co-ordinated zip strip and hanging loop
- Fabric carry-handle 460mm length with leather-like grip
- Business card holder on front

IDEAL FOR SCHOOLS



CODE	DESCRIPTION	TRADE PK	OUTER
15870	A4++ (405 x 280mm) Mesh Bag • Black	1 Bag	96 Packs
15871	A4++ (405 x 280mm) Mesh Bag • Blue	1 Bag	96 Packs
15872	A4++ (405 x 280mm) Mesh Bag • Red	1 Bag	96 Packs
15873	A4++ (405 x 280mm) Mesh Bag • Yellow	1 Bag	96 Packs
15874	A3 (480 x 350mm) Mesh Bag • Black	1 Bag	60 Packs
15875	A3 (480 x 350mm) Mesh Bag • Blue	1 Bag	60 Packs
15876	A3 (480 x 350mm) Mesh Bag • Red	1 Bag	60 Packs
15877	A3 (480 x 350mm) Mesh Bag • Yellow	1 Bag	60 Packs



AirBag

Since November 2006, European Legislation demands that liquids carried on board an aircraft must be packed in a clear, resealable bag, approximately 20 x 20cm in size.

- Snopake Airbag meets the requirements of this legislation.
- The legislation affects all European flights and has been adopted at many international airports
- Made from tough, long-lasting flexible material
- With smooth action plastic closure and metal slider

CODE	DESCRIPTION	TRADE PK	OUTER
15158	200 x 200mm AirBag • Assorted Blue & Yellow	25 Bags	32 Packs



Sorta-File

- Dividers provide removable sections to separate work
- Business card holder on outside
- Top plastic zip pull
- Gusseted on 3 sides

CODE	DESCRIPTION	TRADE PK	OUTER
15763	A5 Sorta-File • Electra Assorted	25 Bags	10 Packs
15764	A4 Sorta-File • Electra Assorted	25 Bags	10 Packs

Electra Assorted - Blue, Green, Purple, Pink, Turquoise



Zippa High Capacity

- A high-capacity version of the popular A4+ Zippa-Bag
- Gusseted base expands to 60mm wide
- Tinted bag co-ordinates with the colour of the zip-strip
- Made from tough, flexible, hardwearing material

CODE	DESCRIPTION	TRADE PK	OUTER
15299	A4 Plus (370 x 260mm) Zippa HC • Classic Assorted	25 Bags	16 Packs

Classic Assorted - 5 x Blue, 5 x Red, 5 x Yellow, 5 x Green, 5 x Orange



EPPE Zippa-Bag

- Size: A5 & Foolscap in assorted colours and white
- 0.25mm micron thickness EPPE bag
- Top plastic zip pull
- Environmentally friendly and can be recycled

CODE	DESCRIPTION	TRADE PK	OUTER
15813	A5 (255 x 170mm) EPPE Bag • White	5 Bags	40 Packs
15814	A5 (255 x 170mm) EPPE Bag • Assorted	5 Bags	40 Packs
15815	Foolscap (370 x 245mm) EPPE Bag • White	5 Bags	40 Packs
15816	Foolscap (370 x 245mm) EPPE Bag • Assorted	5 Bags	40 Packs

Assorted - 1 x Orange, Green, Purple, Pink, Blue

FILING & STORAGE

Being the premier brand for Filing & Storage products, Snopake not only guarantees innovation but also superior quality. Each one of our Filing & Storage products has the highest standards when it comes to product quality – we are so sure of our promise that we guarantee our products for 5 years.

From our Box Office Files to our DocBox Range to Suspension Files and Clipboards, there's a premium quality Filing & Storage product designed to suit your every need. Since 1955 Snopake has been manufacturing products with the highest quality materials, providing you with premium stationery at an affordable price.

Snopake's Filing & Storage products have been designed with you in mind!





BoxOffice

- A comprehensive range of transparent storage boxes
- Five different sizes to include all popular formats
- There is a BoxOffice available for whatever the storage problem
- Featuring a business card size pocket
- A3+ size is big enough for over-size A3 inkjet paper



CODE	DESCRIPTION	TRADE PK	OUTER
13729	Business Card Size • 15mm Capacity • 0.55mm • Clear	5 Boxes	96 Packs
13781	Business Card Size • 15mm Capacity • 0.55mm • Electra Assorted	5 Boxes	96 Packs
13732	A5 • 20mm Capacity • 0.65mm • Clear	5 Boxes	18 Packs
13801	A5 • 20mm Capacity • 0.65mm • Electra Assorted	5 Boxes	18 Packs
13733	A4 • 25mm Capacity • 0.75mm • Clear	5 Boxes	12 Packs
13806	A4 • 25mm Capacity • 0.75mm • Electra Assorted	5 Boxes	12 Packs

Electra Assorted - 2 x Blue, 1 x Turquoise, 1 x Green, 1 x Purple

CODE	DESCRIPTION	TRADE PK	OUTER
13812	A3 Plus • 30mm Capacity • 0.9mm • Electra Assorted	5 Boxes	1 Pack
13735	A2 • 35mm Capacity • 0.9mm • Clear	5 Boxes	1 Pack
13817	A2 • 35mm Capacity • 0.9mm • Electra Assorted	5 Boxes	1 Pack

Electra Assorted - 2 x Blue, 1 x Turquoise, 1 x Green, 1 x Purple



DocBox

- Made from heavy-gauge polypropylene and welded for strength
- Strong colour co-ordinated push-lock for security
- 60mm DocBox has a ring-pull on spine for easy retrieval from shelf
- Ideal for storage of loose papers
- Accepts documents in Snopake A4 polyfiles



CODE	DESCRIPTION	TRADE PK	OUTER
12849	A4 • 25mm Capacity • 0.75mm • Clear	1 Box	40 Packs
12845	A4 • 25mm Capacity • 0.75mm • Dark Blue	1 Box	40 Packs
14832	A4 • 25mm Capacity • 0.75mm • Electra Assorted	5 Boxes	8 Packs
12861	A4 • 35mm Capacity • 0.75mm • Clear	1 Box	40 Packs
12858	A4 • 35mm Capacity • 0.75mm • Dark Blue	1 Box	40 Packs
12871	A4 • 60mm Capacity • 0.9mm • Clear	1 Box	20 Packs
12867	A4 • 60mm Capacity • 0.9mm • Dark Blue	1 Box	20 Packs

Electra Assorted - 1 x Blue, 1 x Green, 1 x Purple, 1 x Turquoise, 1 x Pink



PenPal

- Handy fun and colourful boxes
- Easy-to-access slide-out inner drawer
- Secure Snopake press-stud closure
- Write on label suitable for personalisation

CODE	DESCRIPTION	TRADE PK	OUTER
12940	200 x 75 x 30mm PenPal • Electra Assorted	5 Boxes	32 Packs

Electra Assorted - 1 x Blue, 1 x Green, 1 x Pink, 1 x Purple, 1 x Turquoise



Polka Dot PenPal

- Easy-to-access clear slide-out inner drawer
- Secure white Snopake press-stud closure
- Write on label suitable for personalisation

* Other products within this range are available

CODE	DESCRIPTION	TRADE PK	OUTER
15765	200 x 75 x 30mm Polka Dot PenPal • Polka Dot Print	5 Boxes	32 Packs



Metallic ClipBoard

- Strong and lightweight with a hole for hanging
- 2.5mm thick board with measurement guides
- Heavy duty clip ensures papers are held securely
- For use with A4 papers, forms and documents

CODE	DESCRIPTION	TRADE PK	OUTER
15788	For A4 paper • Metallic Silver	1 Board	60 Packs



ClipBoard With Pen

- Strong and lightweight with a hole for hanging
- Complete with colour co-ordinated pen
- Handy built-in penholder for convenience
- For use with A4 papers, forms and documents

CODE	DESCRIPTION	TRADE PK	OUTER
13900	For A4 paper • Electra Assorted	10 Boards	6 Packs

Electra Assorted - 2 x Blue, 2 x Green, 2 x Pink, 2 x Purple, 2 x Turquoise

Clipboard

- Strong and lightweight with a hole for hanging
- 2.3mm thick board
- Ergonomic design, heavy duty metal clip mechanism ensures papers are held securely
- Handy built-in penholder for convenience
- String hole gives additional feature for use
- For use with A4 papers, forms and documents



CODE	DESCRIPTION	TRADE PK	OUTER
15886	A4 • Blue	1 Board	60 Packs
15887	A4 • Turquoise	1 Board	60 Packs

Double-Sided Whiteboard

- Erasable double-sided whiteboard is blank on one side and graphed on the other, making it ideal for learning to write
- Includes an eraser that clips onto the whiteboard
- Includes a dry wipe whiteboard pen*
- Hanging hook for convenience



CODE	DESCRIPTION	TRADE PK	OUTER
15889	Whiteboard with Pen & Eraser • Blue	1 Board	96 Packs
15890	Whiteboard with Pen & Eraser • Green	1 Board	96 Packs
15891	Whiteboard with Pen & Eraser • Red	1 Board	96 Packs
15892	Whiteboard with Pen & Eraser • Yellow	1 Board	96 Packs

* shelf life of pen - 1 year



287 x 205 x 18mm

HangGlider Clear Suspension File

- User-friendly suspension system for tidy and efficient filing
- Colour-coded plastic rails glide smoothly, won't catch, bend or buckle
- Includes click-lock index tabs that can be positioned at any point along the rail
- Includes 108 paper inserts
- Width between HangGlider bar: Foolscap 405mm, A4 349mm



CODE	DESCRIPTION	TRADE PK	OUTER
15857	Foolscap Suspension File • Clear	Box of 25 Files	8 Packs
15858	A4 Suspension File • Clear	Box of 25 Files	8 Packs
10278	Index Tab Plastic Holders • Clear	Box of 25 Tabs	40 Packs



Foolscap

A4

HangGlider Suspension File

- User-friendly suspension system for tidy and efficient filing
- Colour-coded plastic rails glide smoothly, won't catch, bend or buckle
- Includes click-lock index tabs that can be positioned at any point along the rail
- Includes 108 paper inserts
- Width between HangGlider bar: Foolscap 405mm, A4 349mm



CODE	DESCRIPTION	TRADE PK	OUTER
10279	Foolscap Suspension File • Black	Box of 25 Files	8 Packs
10296	A4 Suspension File • Black	Box of 25 Files	8 Packs
10278	Index Tab Plastic Holders • Clear	Box of 25 Tabs	40 Packs



Foolscap

A4

Assorted - 5 x Blue, 5 x Green, 5 x Purple, 5 x Red, 5 x Yellow

Snopake® RECOMMENDS

Rainbow Suspension Expander

- Extendable suspension hooks
- 13 expanding sections for papers and documents
- 2 x elastic closures
- Index tabs enclosed to help divide sections
- Fits into filing cabinets perfectly

* Other products within this range are available



CODE	DESCRIPTION	TRADE PK	OUTER
15802	A4 Suspension Expander • Rainbow	1 Expander	40 Packs
15803	Foolscap Suspension Expander • Rainbow	1 Expander	40 Packs

x275

MAX SHEET CAPACITY

x13

INDEXING SYSTEM

0.7mm

THICKNESS

x1

BUSINESS CARD HOLDER

5 YEARS

GUARANTEE



x100

MAX SHEET CAPACITY

CLAMPBINDER

65mm

0.75mm

THICKNESS

5 YEARS

GUARANTEE

ClampBinder

- The easy way to file unpunched paper
- Clamp mechanism to instantly secure paper
- Holds up to 100 sheets of 80gsm unpunched paper
- Reversible spine label for personalisation

CODE	DESCRIPTION	TRADE PK	OUTER
12772	A4 ClampBinder • Clear	10 Files	6 Packs
12790	A4 ClampBinder • Electra Assorted	10 Files	6 Packs

Electra Assorted - 3 x Blue, 1 x Green, 1 x Pink, 3 x Purple, 2 x Turquoise



A4

x30

MAX SHEET CAPACITY

0.4mm

THICKNESS

5 YEARS

GUARANTEE

ClipFile

- A smart and robust presentation file
- Simple side-clip that instantly secures unpunched pages
- Made from strong polypropylene with a 0.4mm back cover and 0.2mm front cover
- Executive Clipfile features a Superline transparent front cover

CODE	DESCRIPTION	TRADE PK	OUTER
12677	A4 4mm Clip • Bright Assorted	5 Files	40 Packs

Bright Assorted - 1 x Green, 1 x Pink, 1 x Purple, 1 x White, 1 x Yellow



-
-
-
-
-

TwinFile

- An elegant, everyday presentation file for loose documents
- Two internal storage pockets
- Features business card holder on front cover and inside front cover
- Ideal for contracts, quotations, proposals and estimates
- Made from wipe-clean polypropylene

CODE	DESCRIPTION	TRADE PK	OUTER
14030	A4 (335 x 240mm) TwinFile • Clear	5 Files	40 Packs
14031	A4 (335 x 240mm) TwinFile • Electra Assorted	5 Files	40 Packs
14032	A4 (335 x 240mm) TwinFile • Electra Blue	5 Files	40 Packs

Electra Assorted - 1 x Blue, 1 x Green, 1 x Pink, 1 x Purple, 1 x Turquoise



-
-
-
-
-

Presentation TwinFile

- Elegant file with front cover pocket for presentations
- Two internal storage pockets
- Made from wipe-clean polypropylene
- Ideal for presenting proposals, reports, contracts and quotations

CODE	DESCRIPTION	TRADE PK	OUTER
14920	A4 (335 x 245mm) • Clear	5 Files	40 Packs



-
-
-
-
-
-

SlipFile

- 5 part desktop file to keep documents and paper tidy and organised
- Open two sides with five handy index tabs, together with a set of blank labels
- Contents in each pocket can be quickly and easily identified and retrieved
- Features business card holder on front cover
- Premium quality polypropylene for a professional appearance

CODE	DESCRIPTION	TRADE PK	OUTER
15055	A4 5-Part File • Clear	5 Files	36 Packs



-
-
-
-
-

SwingFile

- Attractive, stylish file for unpunched paper
- Ergonomic, simple swivel clip that grips paper securely
- Holds up to 30 sheets of 80gsm paper
- Smart Superline finish for professional presentation

CODE	DESCRIPTION	TRADE PK	OUTER
14997	A4 SwingFile • Electra Assorted	5 Files	20 Packs

Electra Assorted - 1 x Blue, 1 x Green, 1 x Pink, 1 x Purple, 1 x Turquoise



Fusion VariFile

- Guaranteed premium quality polypropylene with clear Superline, embossed finish
- A4-sized gusseted 5 part file
- Can file in portrait and landscape
- 140 Sheet Capacity, 80gsm new paper

* Other products within this range are available

CODE	DESCRIPTION	TRADE PK	OUTER
15700	A4 File • Fusion Assorted	5 Files	20 Packs

Fusion Assorted: 1 x Indigo, Burgundy, Emerald, Smoke and Plum



FileLastic

- Stylish and secure method of paper storage
- Contrasting colour elastics on Standard and Electra, hold the files closed
- Three internal flaps prevent papers from falling out
- High capacity holds up to 100 Sheets

CODE	DESCRIPTION	TRADE PK	OUTER
12639	A4 File • 0.47mm • Classic Assorted	5 Files	20 Packs
13720	A4 File • 0.47mm • Electra Assorted	5 Files	20 Packs

Classic Assorted - 1 x Blue, 1 x Green, 1 x Yellow, 1 x Red, 1 x Clear
Electra Assorted - 1 x Blue, 1 x Green, 1 x Pink, 1 x Purple, 1 x Turquoise



FileLastic 8-Part

- 8-part file with unique A-Z / 1-8 duo-index
- Ideal for storing papers and organising things to do
- Paper index strip on front cover for titles or section headings
- Elasticated closure secures contents

CODE	DESCRIPTION	TRADE PK	OUTER
14965	A4 8-Part file • Electra Assorted	5 Files	12 Packs

Electra Assorted - 1 x Blue, 1 x Green, 1 x Pink, 1 x Purple, 1 x Turquoise



FileLastic 8-Part Rainbow

- 8-part file with unique A-Z / 1-8 duo-index
- Ideal for storing papers and organising things to do
- Paper index strip on front cover for titles or section headings
- Elasticated closure secures contents

* Other products within this range are available

CODE	DESCRIPTION	TRADE PK	OUTER
15804	A4 8-Part file • Rainbow Assorted	5 Files	12 Packs

Rainbow Assorted: 1 x Blue, Green, Orange, Purple and Red

POLYFILES

The Snopake Polyfile, launched in 1995, is the original envelope-style popper-wallet - it's often copied but never excelled. Snopake Polyfiles are made from tough polypropylene, much stronger than the material used by many competitors, and the press-stud closure is engineered to last. Snopake Polyfiles are ideal for securing all your important documents, photographs and artwork, whether at home, in school or the workplace.

Uniquely, only Snopake Polyfiles have double-welded seams, making them the toughest files of this type available - anywhere! The Snopake Polyfile is durable, elegant and resourceful - it's no wonder one is bought every 6 seconds!

The Polyfile is available in a wide choice of clear, vibrant and soft clear pastel colours, designed to suit your every need.

The Classic and Clear Polyfile range feature an indexing system - unique to Snopake, allowing you to label each Polyfile for easy identification. This is yet another Snopake innovation - you won't find this on any similar-looking files.



Polyfile

The Snopake Polyfile was launched in 1995, as a tough, elegant and environmentally-friendly alternative to the manila folder. Manufactured from tough, long-lasting polypropylene, it is easy to wipe clean and is available in an array of vibrant colours and soft clear pastels. Complete with a coloured press-stud that ensures that documents stay safely inside the folder.

Did you know that a Snopake Polyfile is bought somewhere in the world every 6 seconds?

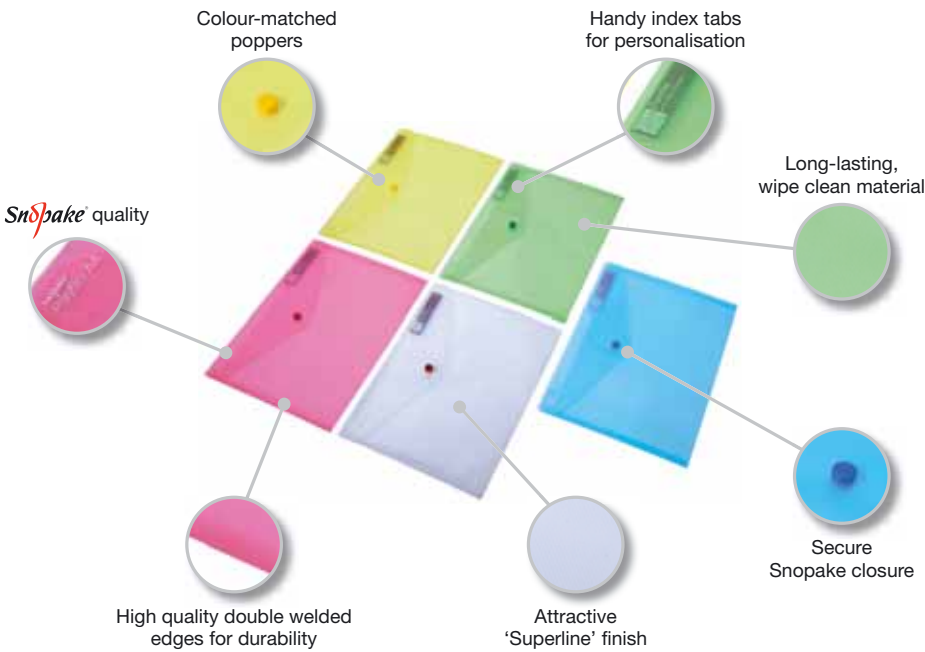

We've done it again!

Now after 22 years of global success, there's a new Polyfile. Unlike any other, the seams are double-welded for ultimate strength and security.



Polypropylene is one of the most widely used plastics in the world it is robust, extremely durable, water resistant and recyclable.



Available in sizes from A7 to A3, there is a Polyfile to meet all needs - from storing documents, artwork, CD's and photographs to holding business cards.

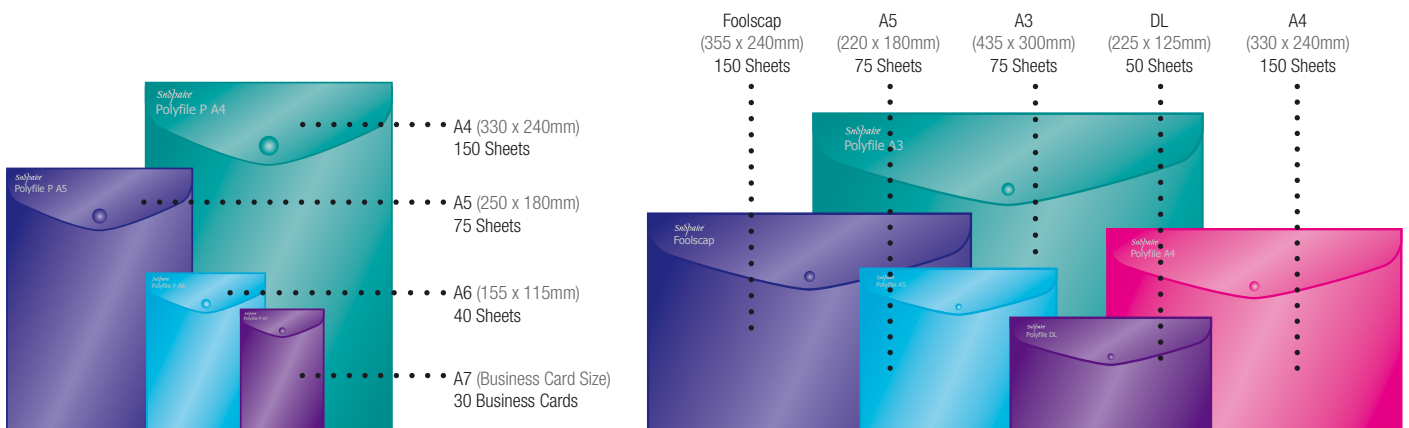

The Unique Snopake Indexing System
(Clear and Classic only)



Snopake® RECOMMENDS



Clear and Classic Polyfiles in A4, Foolscap & A3 feature a handy indexing system, unique to Snopake.



Polyfile

- Features a press-stud closure to keep the contents safe and secure
- Strong polypropylene material with an attractive superline emboss
- Available in a wide choice of popular Classic, Clear or stunning Electra colours
- Clear and Classic Polyfiles feature a handy indexing system, unique to Snopake
- See page 32 for sheet capacities

CODE	DESCRIPTION	TRADE PK	OUTER
10057	DL (225 x 125mm) Polyfile • Clear	5 Files	40 Packs
10070	DL (225 x 125mm) Polyfile • Classic Assorted	5 Files	40 Packs
10035	DL (225 x 125mm) Polyfile • Electra Assorted	5 Files	40 Packs
11360	A5 (220 x 180mm) Polyfile • Blue	5 Files	40 Packs
11382	A5 (220 x 180mm) Polyfile • Clear	5 Files	40 Packs
11395	A5 (220 x 180mm) Polyfile • Classic Assorted	5 Files	40 Packs
11355	A5 (220 x 180mm) Polyfile • Electra Assorted	5 Files	40 Packs
11174	A3 (435 x 300mm) Polyfile • Clear	5 Files	20 Packs
10742	A3 (435 x 300mm) Polyfile • Classic Assorted	5 Files	20 Packs
11185	A3 (435 x 300mm) Polyfile • Electra Assorted	5 Files	20 Packs
12838X	A4 (330 x 240mm) Polyfile • Blue	5 Files	40 Packs
12839X	A4 (330 x 240mm) Polyfile • Red	5 Files	40 Packs
12840X	A4 (330 x 240mm) Polyfile • Yellow	5 Files	40 Packs
12841X	A4 (330 x 240mm) Polyfile • Clear	5 Files	40 Packs
12843X	A4 (330 x 240mm) Polyfile • Classic Assorted	5 Files	40 Packs
12844	A4 (330 x 240mm) Polyfile • Electra Assorted	5 Files	40 Packs

CODE	DESCRIPTION	TRADE PK	OUTER
11151X	Foolscap (355 x 240mm) Polyfile • Blue	5 Files	40 Packs
11152X	Foolscap (355 x 240mm) Polyfile • Red	5 Files	40 Packs
11154X	Foolscap (355 x 240mm) Polyfile • Clear	5 Files	40 Packs
10087X	Foolscap (355 x 240mm) Polyfile • Classic Assorted	5 Files	40 Packs
11162	Foolscap (355 x 240mm) Polyfile • Electra Purple	5 Files	40 Packs
11160	Foolscap (355 x 240mm) Polyfile • Electra Green	5 Files	40 Packs
11164	Foolscap (355 x 240mm) Polyfile • Electra Blue	5 Files	40 Packs
10088	Foolscap (355 x 240mm) Polyfile • Electra Assorted (A)	5 Files	40 Packs
15775	Portrait Polyfile Pack • Electra Assorted (B)	5 Files	40 Packs
15776	Landscape Polyfile Pack • Electra Assorted (C)	5 Files	40 Packs

Classic Assorted - 1 x Clear, 1 x Blue, 1 x Yellow, 1 x Green, 1 x Red
 Electra Assorted (A) - 1 x Blue, 1 x Green, 1 x Pink, 1 x Purple, 1 x Turquoise
 Electra Assorted (B) - 1 x Blue, 1 x Green, 1 x Pink, 1 x Turquoise
 Electra Assorted (C) - 1 x Green, 1 x Purple, 1 x Turquoise



Polyfile Duo

- Size: A4 and A5
- Index system for personalisation

CODE	DESCRIPTION	TRADE PK	OUTER
15693	A4/A5 Polyfile Duo • Electra Assorted	5 Files	40 Packs

Electra Assorted - 1 x Blue, 1 x Green, 1 x Pink, 1 x Purple, 1 x Turquoise



Polyfile Twin Pocket

- Size: A4 & Foolscap, Electra colours in A4 size only
- Index system for personalisation in Clear only
- Side gussets to allow easy opening and additional capacity

CODE	DESCRIPTION	TRADE PK	OUTER
15690	Foolscap (355 x 240mm) Polyfile Twin Pocket • Clear	5 Files	40 Packs
15691	A4 Polyfile Twin Pocket • Electra Assorted	5 Files	40 Packs

Electra Assorted - 1 x Blue, 1 x Green, 1 x Pink, 1 x Purple, 1 x Turquoise

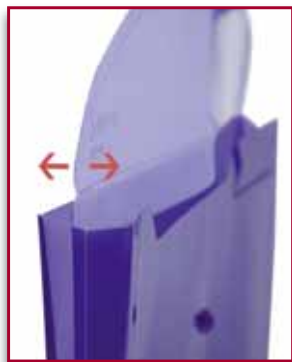

DESIGN REGISTRATION



Polyfile USB

- Size: A4 & Foolscap
- Index system for personalisation
- Holds standard USB stick with easy retrievable system behind
- Hook and loop closure

CODE	DESCRIPTION	TRADE PK	OUTER
15688	A4 Polyfile USB • Electra Assorted	5 Files	40 Packs
15689	Foolscap (355 x 240mm) Polyfile USB • Electra Asstd	5 Files	40 Packs

Electra Assorted - 1 x Blue, 1 x Green, 1 x Pink, 1 x Purple, 1 x Turquoise



Bio₂ Polyfile

- Made from strong, 100% biodegradable polypropylene
- Green press-stud closure keeps contents secure
- Clear frost emboss for easier identification of content

* Other products within this range are available

CODE	DESCRIPTION	TRADE PK	OUTER
15428	A4 Polyfile • Clear	5 Files	40 Packs

Lite Polyfile

- Available in five exciting Lite colours
- Press-stud closure with Snopake logo
- Strong polypropylene with an attractive frost emboss

* Other products within this range are available

CODE	DESCRIPTION	TRADE PK	OUTER
15411	A4 Polyfile • Assorted	5 Files	40 Packs
15412	A4 Polyfile • Clear	5 Files	40 Packs

Assorted - 1 x Parchment, 1 x Light Blue, 1 x Dark Blue, 1 x Pink, 1 x Purple



Polyfile ID

- Featuring a business card size index pocket
- Available in stunning Electra or confidential opaque colours
- Attractive high-gloss superline finish
- Designed for A4 paper and filing systems

CODE	DESCRIPTION	TRADE PK	OUTER
12491	A4 (330 x 240mm) Polyfile ID • Black	5 Files	40 Packs
12560	A4 (330 x 240mm) Polyfile ID • Clear	5 Files	40 Packs
12565	A4 (330 x 240mm) Polyfile ID • Bright Assorted	5 Files	40 Packs
14734	A4 (330 x 240mm) Polyfile ID • Electra Assorted	5 Files	40 Packs

Bright Assorted - 1 x Green, 1 x Pink, 1 x Purple, 1 x White, 1 x Yellow
 Electra Assorted - 1 x Blue, 1 x Green, 1 x Pink, 1 x Purple, 1 x Turquoise



Rainbow Polyfile ID

- Featuring a business card sized index pocket
- Attractive high-gloss superline finish
- Designed for A4 paper and filing systems

* Other products within this range are available

CODE	DESCRIPTION	TRADE PK	OUTER
15787	A4 (330 x 240mm) Polyfile ID • Rainbow Assorted	5 Files	40 Packs

Rainbow Assorted: 1 x Blue, Green, Orange, Purple and Red



Fusion Polyfile

- Tough, long lasting polypropylene
- Superline, embossed finish
- Press stud closure
- Holds A4 paper

* Other products within this range are available

CODE	DESCRIPTION	TRADE PK	OUTER
15643	A4 Polyfile • Fusion Assorted	5 Files	40 Packs

Fusion Assorted: 1 x Indigo, Burgundy, Emerald, Smoke and Plum

Polyfile P

- Portrait wallets for upright filing, storage and presentation
- Snopake press-stud closure keeps contents secure inside
- Smart Superline finish for professional presentation and everyday protection
- Clear file enables easier identification of contents
- See page 32 for sheet capacities

CODE	DESCRIPTION	TRADE PK	OUTER
13306	A7 (115 x 80mm) Polyfile P • Clear	5 Files	40 Packs
13300	A7 (115 x 80mm) Polyfile P • Electra Assorted	5 Files	40 Packs
13293	A6 (155 x 115mm) Polyfile P • Clear	5 Files	40 Packs
13287	A6 (155 x 115mm) Polyfile P • Electra Assorted	5 Files	40 Packs
13280	A5 (250 x 180mm) Polyfile P • Clear	5 Files	40 Packs
13274	A5 (250 x 180mm) Polyfile P • Electra Assorted	5 Files	40 Packs
13263	A4 (330 x 240mm) Polyfile P • Clear	5 Files	40 Packs
13266	A4 (330 x 240mm) Polyfile P • Electra Assorted	5 Files	40 Packs

Electra Assorted - 1 x Blue, 1 x Green, 1 x Pink, 1 x Purple, 1 x Turquoise



TIP Designed for upright filing, **Polyfile P** has a top opening and is in portrait format. With all the benefits of the original Polyfile range, Polyfile P also allows for easy and instant retrieval of documents from a backpack.



Polka Dot Polyfile

- Can hold Foolscap punch-less filing
 - White press stud closure
 - Ideal for home, work and school
- * Other products within this range are available

CODE	DESCRIPTION	TRADE PK	OUTER
15742	Foolscap (360 x 240mm) Polyfile • Polka Dot	5 Files	40 Packs



Polyfile CD

- A Polyfile designed to hold a CD and loose documents
- Great for storing or presenting hard copy documents and the associated computer files together
- The CD can be stored either in or out of its case
- The gusseted file means extra large paper capacity

CODE	DESCRIPTION	TRADE PK	OUTER
11800	A4 (330 x 240mm) Polyfile CD • Electra Assorted	5 Files	40 Packs

Electra Assorted - 1 x Blue, 1 x Green, 1 x Pink, 1 x Purple, 1 x Turquoise





Craft Polyfile

- Ideal for storing craft books, scrap books, crafts etc
- Red press stud closure
- Attractive high-gloss superline finish



CODE	DESCRIPTION	TRADE PK	OUTER
15832	13 x 13" Craft Polyfile • Clear	5 Files	40 Packs



Polyfile Trio

- Polyfile with three sections for storing documents, notes, pens and paper
- Press-stud closure keeps contents safe and secure
- Includes index tabs for labelling the three sections



CODE	DESCRIPTION	TRADE PK	OUTER
14966	Foolscap (355 x 240mm) Polyfile Trio • Clear	5 Files	20 Packs
14967	Foolscap (355 x 240mm) Polyfile Trio • Electra Assorted	5 Files	20 Packs

Electra Assorted - 1 x Blue, 1 x Green, 1 x Pink, 1 x Purple, 1 x Turquoise



PolyPlus

- A heavier duty polypropylene wallet file
- Sealed corners prevent small items such as pencils from falling out
- Twin Snopake press-stud closures keep contents safe and secure
- A business card pocket on the front for personalisation



CODE	DESCRIPTION	TRADE PK	OUTER
11756	A4 PolyPlus • 0.55mm • Electra Assorted	5 Files	5 Packs

Electra Assorted - 2 x Blue, 1 x Green, 1 x Purple, 1 x Turquoise



PolyWally

- PolyWally is historic - in 1988, it was the first polypropylene file ever to be introduced to the UK. The original long lasting alternative to the manilla wallet.
- Tough wallet files made from wipe-clean polypropylene
- The sealed corners prevent small items such as pencils from falling out
- Index pocket for contents identification



CODE	DESCRIPTION	TRADE PK	OUTER
13853	A4 PolyWally • Electra Assorted	5 Files	20 Packs

Electra Assorted - 2 x Blue, 1 x Green, 1 x Purple, 1 x Turquoise

NOTEBOOKS & DISPLAY BOOKS

Snopake Display Books are sure to impress in any circumstances. The versatility of our display books means they can be used for presentations, for interviews, for filing contracts but can also be used around the home for storing menus or important household documents in an easy to read format. Made from tough polypropylene, our display books have wrap around spines for easy identification and labelling as well as a variety of pocket sizes. We actually have display books that are A5 and A4 in size but can store A4 and A3 paper - that's what we call flexibility!



Snpake[®] RECOMMENDS

eligo ReOrganiser Project Books

- A4 & A5 Project books with colour codes index tabs to help identify and locate sections
- Indexes and pages can be removed, rearranged or replaced instantly
- 80gsm FSC[®] white lined paper
- Tough Polypropylene cover with handy card holder on front and an inside pocket

* Other products within this range are available



CODE	DESCRIPTION	TRADE PK	OUTER
15861	A5 ReOrganiser Project Book • 75 Sheets/150 Pages • Black	1 Book	30 Packs
15862	A4 ReOrganiser Project Book • 75 Sheets/150 Pages • Black	1 Book	20 Packs
15864	A5 ReOrganiser Refill Paper	1 Pack	60 Packs
15865	A4 ReOrganiser Refill Paper	1 Pack	40 Packs



eligo ReOrganiser Display Book

- A4 Display book with colour codes index tabs to help identify and locate sections
- Indexes and pockets can be removed, rearranged or replaced instantly
- Tough Polypropylene cover with handy card holder on front and an inside pocket



CODE	DESCRIPTION	TRADE PK	OUTER
15863	A4 ReOrganiser Display Book • 20 Pockets • Black	1 Book	30 Packs
15866	A4 ReOrganiser Refill Pockets	1 Pack	100 Packs



eligo 10-Pocket Display Book

- Slim, flexible display book with 0.5mm black cover
- Welded clear pockets to ensure contents are secure
- Coloured spine & back cover for easy identification of different project or subjects
- Business card holder on front for easy reference
- Inside pocket on front cover for loose notes and papers



CODE	DESCRIPTION	TRADE PK	OUTER
15888	A4 Display Book • 10 Pkt (20 sides to view) • Black	5 Books	10 Packs



Noteguard Hardback

- 80gsm FSC® white lined paper
- High quality wire-bound notebook with elasticated closure and inside pocket
- A4 and A5 versions include detachable ruler, page marker and card holder
- A4, A5 & A6 versions include informative page for contacts, conversion tables, International dialling codes and clothing sizes
- 3" x 5" version with micro-perforated pages - ideal for shopping lists and messages
- Tough polypropylene cover



CODE	DESCRIPTION	TRADE PK	OUTER
14324	127 x 76mm (3 x 5") NoteGuard • 60 sheets/120 pages • Electra Asstd	5 Books	48 Packs
14323	A6 NoteGuard • 75 sheets/150 pages • Electra Assorted	5 Books	24 Packs
14322	A5 NoteGuard • 75 sheets/150 pages • Electra Assorted	5 Books	16 Packs
14321	A4 NoteGuard • 75 sheets/150 pages • Electra Assorted	5 Books	8 Packs

Electra Assorted - 1 x Blue, 1 x Green, 1 x Purple, 1 x Turquoise, 1 x Pink



Zipit Presentation ReOrganiser Display Book

- Professional display book allowing pages to be removed, rearranged or replaced instantly
- Features cover pocket for presentation & title pages
- Inside pocket for loose notes and papers
- Write on spine label
- Glass clear interior pockets are securely fixed to spine



CODE	DESCRIPTION	TRADE PK	OUTER
15779	A4 Presentation Display Book • 20 Pockets • Black	1 Book	40 Packs
15780	A4 Presentation Display Book • 40 Pockets • Black	1 Book	30 Packs
15781	A4 Presentation Display Book • 60 Pockets • Black	1 Book	20 Packs
15869	A4 Zipit ReOrganiser Refill Pockets	1 Pack	50 Packs



Polyfile Display Book

- A4 20-pocket Display Book with 40 sides to view
- Integral A4 Polyfile wallet at back of book, ideal for storing accompanying material
- Full length spines for project identification



CODE	DESCRIPTION	TRADE PK	OUTER
12367	A4 Display Book • 20 Pockets (40 sides to view) • Blue	5 Books	8 Packs



Sndpake® RECOMMENDS



-
- 0.4mm**
THICKNESS
-
- 5 YEARS**
GUARANTEE

Electra Display Book

- Tough, wipe-clean smart covers with superline emboss
- Full-length wrap-around spine label for easy identification

CODE	DESCRIPTION	TRADE PK	OUTER
12199	A4 Display Book • 10 Pkt (20 sides to view) • Electra Assorted (A)	10 Books	6 Packs
12219	A4 Display Book • 24 Pkt (48 sides to view) • Electra Assorted (A)	10 Books	6 Packs
14103	A3 Display Book • 24 Pkt (48 sides to view) • Electra Assorted (B)	5 Books	8 Packs

Electra Assorted A - 2 x Blue, 2 x Green, 2 x Pink, 2 x Purple, 2 x Turquoise
 Electra Assorted B - 1 x Blue, 1 x Green, 1 x Pink, 1 x Purple, 1 x Turquoise



- Sales 20L**
WRITE-ON LABEL
- 0.5mm**
THICKNESS
-
- 2 YEARS**
GUARANTEE

Lite Display Book

- Robust polypropylene cover with a frost emboss
- Available in 20 and 40 pocket versions
- Full length wraparound label for personalisation

* Other products within this range are available

CODE	DESCRIPTION	TRADE PK	OUTER
15413	A4 Display Book • 20 Pockets (40 sides to view) • Assorted	12 Books	8 Packs
15415	A4 Display Book • 40 Pockets (80 sides to view) • Assorted	12 Books	5 Packs

Assorted - 2 x Parchment, 2 x Light Blue, 2 x Dark Blue, 2 x Pink, 2 x Purple, 2 x Clear



I hold either A3 or A4 Paper

- A3/A4**
- 0.5mm**
THICKNESS
-
- 5 YEARS**
GUARANTEE

Fusion Display Book

- Tough, long lasting polypropylene
- A3 size display book that folds also folds to A4
- Colour edging on the leading first half of the book
- Tough wipe clean cover

* Other products within this range are available

CODE	DESCRIPTION	TRADE PK	OUTER
15637	A3/A4 Display Book • 20 Pkt (40 sides to view) • Fusion Assorted	5 Books	8 Packs

Fusion Assorted: 1 x Indigo, Burgundy, Emerald, Smoke and Plum

Sndpake® RECOMMENDS



-
- 0.4mm**
THICKNESS
-
- 5 YEARS**
GUARANTEE

Rainbow Display Book

- Tough Wipe Clean Covers with superline emboss
- Index area on spine label for easy identification

* Other products within this range are available

CODE	DESCRIPTION	TRADE PK	OUTER
15808	A4 Display Book • 24 Pkt (48 sides to view) • Rainbow Assorted	5 Books	15 Packs

Rainbow Assorted: 1 x Blue, Green, Orange, Purple and Red



Presentation Display Book

- Professional-quality display book with cover pocket for presentation & titles
- Inside pocket for loose notes and papers
- Write on spine label
- Glass clear interior pockets are securely fixed to spine

CODE	DESCRIPTION	TRADE PK	OUTER
15782	A4 Display Book • 20 Pockets • Black	1 Book	40 Packs
15783	A4 Display Book • 40 Pockets • Black	1 Book	30 Packs
15784	A4 Display Book • 60 Pockets • Black	1 Book	20 Packs



20 Pocket



40 & 60 Pocket



Presentation Display Book

- Strong and rigid covers with Superline emboss
- Clear cover enables front page to be viewed, ideal for personalisation and presentations
- Available from A5 to A3 in either 10 or 20 pocket versions

CODE	DESCRIPTION	TRADE PK	OUTER
11941	A5 Display Book • 20 Pocket (40 sides to view) • Clear	1 Book	120 Packs
11951	A4 Display Book • 20 Pocket (40 sides to view) • Clear	1 Book	60 Packs
11954	A3 Display Book • 20 Pocket (40 sides to view) • Clear	1 Book	40 Packs



RingBinder not included

RingBinder Display Book

- Slim 20-pocket display book with multi-punched, reinforced spine
- A neat, quick way to file related documents in ringbinders and lever arch files
- Also useful for mini-presentations, customer proposals and illustrated sheets
- Superline cover protects contents

CODE	DESCRIPTION	TRADE PK	OUTER
14890	A4 Display Book • 20 Pockets (40 sides to view) • Clear	5 Books	10 Packs



Indexed Display Book

- A4 Display Book that incorporates an indexing system on every display pocket
- Complete with colour-coded index tabs to help identify and locate pages
- Full-length spine label for project identification
- Tough cover material with a handy card holder on front cover

CODE	DESCRIPTION	TRADE PK	OUTER
12340	A4 Display Book • 40 Pockets (80 sides to view) • Black	5 Books	4 Packs



RINGBINDERS

Available in stunning Electra colours and manufactured from the highest quality polypropylene, Snpake RingBinders weigh less and last longer than traditional RingBinders.

The Snpake RingBinder is the ideal document storage solution. You can use the robust and versatile RingBinders to store and organise revision notes, important work documents and even documents around the house i.e menus & bills.

Snpake RingBinders offer a choice of capacities, ring mechanisms and sizes, with a smart superline finish and added value features, our RingBinders are designed to meet your every need.



RingBinders

With a smart superline finish and added value features, our ring binders are designed to meet the needs of students, home users and professionals.

Snopake offers one of the widest range of ring binders on the market, with a choice of capacities, ring mechanisms, colours and sizes.

SNOPAKE RINGBINDER FEATURES & ACCESSORIES



Clear, Classic, Polka Dot & Electra colours



Easy to organise



'D-Ring' and 'O-Ring' mechanisms



'2-Ring' and '4-Ring' mechanisms



Range of capacities and sizes



Personalised Covers



Punched Pockets



Inside Pocket



Business Card Holder



Spine Label



RingBinder Wallets



RingBinder & Wallet

RingBinder 2-Ring

- Weighs less and lasts longer than traditional designs
- Oversized design ensures that page tabs are not damaged
- Full-length wraparound index holder on the spine
- Pocket for loose papers inside the front cover
- Business card holder for personalisation
- High-gloss covers with superline emboss

CODE	DESCRIPTION	TRADE PK	OUTER
10108	A5 • 2-Ring • 15mm Capacity (2/15) • Clear	10 Binders	6 Packs
10109	A5 • 2-Ring • 15mm Capacity (2/15) • Electra Blue	10 Binders	6 Packs
10119	A4 • 2-Ring • 15mm Capacity (2/15) • Clear	10 Binders	6 Packs
10120	A4 • 2-Ring • 15mm Capacity (2/15) • Electra Blue	10 Binders	6 Packs
10126	A4 • 2-Ring • 15mm Capacity (2/15) • Electra Assorted	10 Binders	6 Packs
10183	A4 • 2-Ring • 25mm Capacity (2/25) • Clear	10 Binders	6 Packs
10180	A4 • 2-Ring • 25mm Capacity (2/25) • Classic Blue	10 Binders	6 Packs
10181	A4 • 2-Ring • 25mm Capacity (2/25) • Classic Red	10 Binders	6 Packs
10182	A4 • 2-Ring • 25mm Capacity (2/25) • Classic Yellow	10 Binders	6 Packs
10159	A4 • 2-Ring • 25mm Capacity (2/25) • Electra Blue	10 Binders	6 Packs
10165	A4 • 2-Ring • 25mm Capacity (2/25) • Electra Assorted	10 Binders	6 Packs

Electra Assorted - 3 x Blue, 1 x Green, 1 x Pink, 3 x Purple, 2 x Turquoise



Bio₂ RingBinder

- Made from strong, 100% biodegradable polypropylene
- 25mm capacity with secure 2 'O' mechanisms
- Full length index holder on the spine
- Clear frost emboss for easier identification of content

* Other products within this range are available



CODE	DESCRIPTION	TRADE PK	OUTER
15431	A4 • 2-Ring • 25mm Capacity (2/25) • Clear	10 Binders	6 Packs

Sndpake® RECOMMENDS



Polka Dot RingBinder

- 25mm 2 'O' ring RingBinder
- 0.75mm thick white ringbinder with 4 colour print on both sides
- Full length index holder on spine
- Pocket for loose papers on inside of the front cover

* Other products within this range are available



CODE	DESCRIPTION	TRADE PK	OUTER
15738	A4 • 2-Ring • 25mm Capacity (2/25) • Polka Dot	5 Binders	8 Packs



-
-
-
-



-
-
-
-
-

RingBinder Easel

- On the shelf – it's a RingBinder that protects your presentation
- Open it out – and it becomes a presentation easel
- Strong metal press-studs hold the easel erect – or secure the flap when not in use
- Business card holder for easy personalisation/identification
- Comes with FREE x10 punched pockets

CODE	DESCRIPTION	TRADE PK	OUTER
14617	A4 Easel Landscape • Clear	5 Easels	4 Packs

Executive RingBinder

- Premium quality ring binder with extra thick cover
- Made from incredibly strong, free-standing polypropylene
- Frost finish cover and wrap around spine for ease of identification
- Available with 2-ring 'O' mechanism

CODE	DESCRIPTION	TRADE PK	OUTER
13371	A4 • 2-Ring • 25mm Capacity (2/25) • Clear	10 Binders	4 Packs
13372	A4 • 2-Ring • 25mm Capacity (2/25) • Electra Blue	10 Binders	4 Packs
13377	A4 • 2-Ring • 25mm Capacity (2/25) • Electra Assorted	10 Binders	4 Packs

Electra Assorted - 3 x Blue, 1 x Green, 1 x Pink, 3 x Purple, 2 x Turquoise

Snopake® RECOMMENDS



Executive Presentation RingBinder

- Premium quality ringbinder with extra thick front cover pocket for A4 presenter sheets
- 4-ring 'D' mechanism
- Extra thick cover and wrap around spine for ease of personalisation

-
-
-
-
-

CODE	DESCRIPTION	TRADE PK	OUTER
13386	A4 • 4 D-Ring • 25mm Capacity (4/25) • Clear	10 Binders	4 Packs
13387	A4 • 4 D-Ring • 25mm Capacity (4/25) • Electra Blue	10 Binders	4 Packs
13392	A4 • 4 D-Ring • 25mm Capacity (4/25) • Electra Assorted	10 Binders	4 Packs

Electra Assorted - 3 x Blue, 1 x Green, 1 x Pink, 3 x Purple, 2 x Turquoise



Presentation RingBinder 4-Ring

- All the advantages of standard Snopake RingBinders
- Plus front cover pocket for A4 presenter sheet
- Lightweight polypropylene with transparent Superline emboss
- Inner storage pocket with business card holder

-
-
-
-
-

CODE	DESCRIPTION	TRADE PK	OUTER
13368	A4 • 4-Ring • 25mm Capacity (4/25) • Clear	10 Binders	6 Packs

DESIGN REGISTRATION



TripleView

THREE TIMES AS GREAT

STRONGER
SIMPLY THE BEST!
TOUGHER

TripleView RingBinder

RINGBINDER

- Guaranteed premium quality polypropylene with clear Superline, embossed finish RingBinder
- Size: A4, 15 & 25mm capacity – 2 'O' & 'D' ring mechanism
- Ringbinder is 0.9mm thick polypropylene.
- 80 to 150 sheet capacity when Polyfile is filled, 80gsm paper used
- Ideal for office, home and educational users



Polyfile



POLYFILE

- Clear Superline embossed 0.3mm thick polyfile double welded with gussets on 3 sides
- Clear flap on Clear product and Electra flap on Electra assorted products, complete with press-stud closure
- Polyfile available in portrait
- 60 Sheet Capacity per polyfile, 80gsm new paper
- Polyfile on transparent RingBinder cover ideal for presentations

* Other products within this range are available



Code: 15718

Code: 15719

CODE	DESCRIPTION	TRADE PK	OUTER
15716	TripleView A4 RingBinder 2/15 'O-Ring' & Wallet • Clear	5 Binders	12 Packs
15717	TripleView A4 RingBinder 2/25 'O-Ring' & 2 Wallets • Electra Assorted	5 Binders	8 Packs
15718	TripleView A4 RingBinder 2/25 'D-Ring' & Wallet • Electra Assorted	5 Binders	8 Packs
15719	TripleView A4 RingBinder 2/25 'D-Ring' & Wallet • Clear	5 Binders	8 Packs

Electra Assorted - 2 x Pink, 2 x Blue and 1 x Purple



Code: 15716



RingBinder



Polyfile



Code: 15717

RINGBINDER ACCESSORIES

Snopake offers a vast array of RingBinder accessories that are designed to suit virtually any RingBinder or lever arch file. They are available in portrait or landscape, in a variety of colours & sizes and the reinforced, multi-punched edge suits most binding mechanisms.

Every accessory is made from top quality, high strength polypropylene and offers long term protection for your documents or assistance in retrieving those all important documents.

Unlike other brands, Snopake's Polyfile Wallets are double-welded for extra strength and greater durability – another first from Snopake!





RingBinder not included



RingBinder not included



RingBinder Display Book

- Slim 20-pocket display book with multi-punched, reinforced spine
- A neat, quick way to file related documents in ringbinders and lever arch files
- Also useful for mini-presentations, customer proposals and illustrated sheets
- Superline cover protects contents

CODE	DESCRIPTION	TRADE PK	OUTER
14890	A4 Display Book • 20 Pockets (40 sides to view) • Clear	5 Books	10 Packs

A4 Polyfile RingBinder Wallet

- Document wallet with multi-punched edge to suit most binding mechanisms
- Allows unpunched document filing in ringbinders and lever-arch files
- Reinforced edge ensures durability
- Each file features a secure Snopake press-stud closure

CODE	DESCRIPTION	TRADE PK	OUTER
12566	A4 Polyfile RingBinder Wallet • Clear	5 Files	40 Packs



RingBinder not included



A5 Polyfile RingBinder Wallet

- Allows documents to be filed in A5 RingBinders and 2 Ring A4 RingBinders
- Reinforced edge ensures durability
- Each file features a secure Snopake press-stud closure

CODE	DESCRIPTION	TRADE PK	OUTER
15786	A5 Polyfile RingBinder Wallet • Clear	5 Files	40 Packs

Electra Polyfile RingBinder Wallet

- Document wallet with multi-punched edge to suit most binding mechanisms
- Allows unpunched document filing in ringbinders and lever-arch files
- Reinforced edge ensures durability
- Each file features a secure Snopake press-stud closure

CODE	DESCRIPTION	TRADE PK	OUTER
15785	A4 Polyfile RingBinder Wallet • Electra Ass'd	5 Files	40 Packs

Electra Assorted - 1 x Blue, 1 x Green, 1 x Pink, 1 x Purple, 1 x Turquoise

Polyfile High-Capacity RingBinder Wallet

- Guaranteed premium quality polypropylene with clear Superline, embossed finish
- Clear polyfile with gussets on 3 sides with Electra coloured and press stud for ease of closure
- Black edge for reinforcement



CODE	DESCRIPTION	TRADE PK	OUTER
15694	A4 Wallet HC • Landscape • Electra Flap Assorted	5 Files	40 Packs

Electra Assorted - 1 x Blue, 1 x Green, 1 x Pink, 1 x Purple, 1 x Turquoise

DESIGN REGISTRATION



Polyfile High-Capacity RingBinder Wallet

- Guaranteed premium quality polypropylene with clear Superline, embossed finish
- Clear polyfile with gussets on 3 sides with Electra coloured and press stud for ease of closure
- Black edge for reinforcement



CODE	DESCRIPTION	TRADE PK	OUTER
15695	A4 Wallet HC • Portrait • Electra Flap Assorted	5 Files	40 Packs
15749	A4 Wallet HC • Portrait • Clear Flap	5 Files	40 Packs

Electra Assorted - 1 x Blue, 1 x Green, 1 x Pink, 1 x Purple, 1 x Turquoise

DESIGN REGISTRATION



Bio₂ Punched Pockets

- Made from 100% biodegradable polypropylene
- Crystal clear pockets with a distinctive green punched reinforcing edge
- Available in packs of 25 and 100 pockets
- Suitable for use in all types of RingBinders

* Other products within this range are available



CODE	DESCRIPTION	TRADE PK	OUTER
15439	A4 Pack of 25 Pockets • Clear	1 Pack	80 Packs
15440	A4 Pack of 100 Pockets • Clear	1 Pack	20 Packs



RingBinder CardStore

- High-capacity business card file made from strong polypropylene
- Multi-punched spine allows storage in ringbinders and/or lever arch files
- Thumb-cut on pockets for easy access



CODE	DESCRIPTION	TRADE PK	OUTER
14855	A4 CardStore • 5 Pages • 50 Pockets/100 Cards • Clear	5 Files	20 Packs



RingBinder not included

eligo Executive CardFile

- Executive business card file with 25 storage sheets
- Each double-sided page holds 20 business cards
- Includes clear A-Z dividers with coloured tabs to organise and label contents

* Other products within this range are available



CODE	DESCRIPTION	TRADE PK	OUTER
15078	A4 CardFile • 25 Sheet • 500 Card Capacity • Black	1 File	25 Packs



TabFile RingBinder Wallet

- Clear, flat file that opens on one side
- Simple closure tab to secure loose papers
- Perfect for grouping and indexing small batches of paper
- Removable paper insert for labelling



CODE	DESCRIPTION	TRADE PK	OUTER
13727	A4 TabFile RingBinder Wallet • Clear	5 Files	40 Packs



EXPANDING FILES & ORGANISERS

Snopake offers a complete range of Expanding Files & Organisers that are suitable for use on your desktop, carrying around or even for use when travelling.

Unlike other desk organisers, Snopake manufactures its products using thick and long-lasting polypropylene providing you with robust and durable business stationery, without compromising on design and style.

Each Expanding File & Organiser is available in landscape or portrait orientation, different sizes, colours, expanding sections, or with/without carry handles, tailored to suit your every need.



Sndpake® RECOMMENDS



A4 13-Part



A4 6-Part



DL 3-Part



DL 6-Part



Rainbow Expanding Organiser

- Clear organiser with Bright coloured dividers and index sticky labels
- Business card holder on front
- Clear with a push lock closure

* Other products within this range are available

CODE	DESCRIPTION	TRADE PK	OUTER
15767	Rainbow A4 6-Part Expanding Organiser	1 Organiser	30 Packs
15768	Rainbow A4 13-Part Stepped Expanding Organiser	1 Organiser	30 Packs
15769	Rainbow DL 3-Part Expanding Organiser	1 Organiser	48 Packs
15770	Rainbow DL 6-Part Expanding Organiser	1 Organiser	48 Packs

Rainbow Desk Expander

- Clear Desk Expander with bright coloured dividers and index sticky labels
- Multi compartment landscape expander with carry handles
- Expands as filled to remain stable when in use
- Outer cover made from strong 1.2mm thick Polypropylene

* Other products within this range are available



CODE	DESCRIPTION	TRADE PK	OUTER
15809	A4 13-Part Desk Expander • Rainbow	1 Organiser	30 Packs

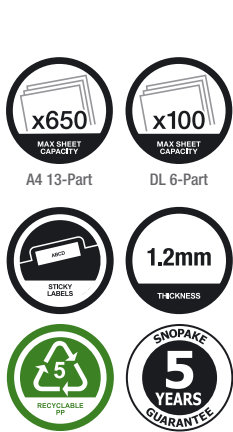

Rainbow & Black Expanding Organiser

- Black organisers with bright coloured dividers and index sticky labels
- Business card holder on front
- Push lock closure

CODE	DESCRIPTION	TRADE PK	OUTER
15849	Rainbow & Black DL 6-Part Expanding Organiser	1 Organiser	30 Packs
15850	Rainbow & Black A4 13-Part Stepped Expanding Organiser	1 Organiser	10 Packs

Rainbow & Black Desk Expanders

- Black Desk Expanders with bright coloured dividers and index sticky labels
- Multi compartment landscape expander with carry handles
- Expands as filled to remain stable when in use
- Outer cover made from strong 1.2mm thick Polypropylene



CODE	DESCRIPTION	TRADE PK	OUTER
15851	Rainbow & Black A4 13-Part Desk Expander	1 Organiser	10 Packs
15852	Rainbow & Black A4 24-Part Desk Expander	1 Organiser	10 Packs



Expanding Organiser

- A stylish range of expanding files
- Organise loose papers and notes
- Includes business card holder and coloured index tabs
- Secure colour co-ordinated closure



CODE	DESCRIPTION	TRADE PK	OUTER
11893	A4 6-Part Organiser • Clear	1 Organiser	30 Packs
13821	A4 6-Part Organiser • Electra Assorted	10 Organisers	3 Packs
11219	A4 13-Part Organiser • Black	1 Organiser	30 Packs

Electra Assorted - 3 x Blue, 1 x Green, 1 x Pink, 3 x Purple, 2 x Turquoise



Electra Multicoloured Organiser

- Elegant expanding document file to organise loose paper and notes
- Clear cover with stunning multicoloured Electra dividers
- Thirteen compartments complete with index tabs
- Business card pocket on cover flap



CODE	DESCRIPTION	TRADE PK	OUTER
15173	A4 13-Part Organiser with Electra Dividers • Clear	1 Organiser	30 Packs

Sndpake® RECOMMENDS

Fusion Travel Holder

- DL-sized 3 part file with tabs printed with Passports, Tickets and Insurance
- Guaranteed premium quality polypropylene with clear Superline, embossed finish
- On the flap on the inside is a business card holder for EHIC card
- Ideal for office and home users

* Other products within this range are available



CODE	DESCRIPTION	TRADE PK	OUTER
15699	DL (240 x 130mm) Organiser • Fusion Assorted	5 Organisers	12 Packs

Fusion Assorted: Smoke, Indigo, Burgundy, Emerald and Plum



Snpake® RECOMMENDS

eligo Landscape Desk Expander

- Elegant expanding organiser for desk and shelf top use
- A brilliant way to sort and file documents – especially where storage space is limited
- 13 & 26 expanding sections for papers and documents
- Easy to carry handles, supplied with index tabs
- Outer cover made from smart, strong 1.8mm Eligo black PP

* Other products within this range are available

CODE	DESCRIPTION	TRADE PK	OUTER
15174	A4 13-Part Desk Expander • Landscape • Black	1 Organiser	40 Packs
15859	Fscap 13-Part Desk Expander • Landscape • Black	1 Organiser	30 Packs
15860	A4 26-Part Desk Expander • Landscape • Black	1 Organiser	20 Packs



eligo Portrait Desk Expander

- Elegant expanding organiser for desk and shelf top use
- A brilliant way to sort and file documents – especially where storage space is limited
- 13 expanding sections for papers and documents
- Supplied with index tabs
- Outer cover made from smart, strong 1.8mm Eligo black PP

* Other products within this range are available

CODE	DESCRIPTION	TRADE PK	OUTER
15171	13-Part Desk Expander • Portrait • Black	1 Organiser	40 Packs



eligo Doc Case & Expander

- Combination of Doc Box and removable 6-part expanding organiser
- Easy to carry with a black handle at the top of the case
- A brilliant way to sort and file documents, papers, manuals etc – especially where storage space is limited
- Made from smart, strong 0.75mm Eligo black PP

* Other products within this range are available

CODE	DESCRIPTION	TRADE PK	OUTER
15697	Doc Case & 6-Part Desk Expander • Black	1 Organiser	24 Packs

Snopake® RECOMMENDS

Zeon Expanding Organiser

- Metallic front with contrasting textured flap
- Soft, stitched vinyl edging
- Discreet Snopake label reinforces an image of quality and style
- Stylish flap closure with colour-coded push-lock for extra security



6-Part



13-Part



0.92mm
THICKNESS



SNOPAKE
5
YEARS
GUARANTEE

CODE	DESCRIPTION	TRADE PK	OUTER
13608	A4 6-Part Organiser • Zeon Assorted	5 Organisers	8 Packs
13701	Foolscap 13-Part Organiser • Zeon Assorted	5 Organisers	6 Packs

Zeon Assorted - 1 x Black, 1 x Blue, 1 x Graphite, 1 x Green, 1 x Red



Fusion Stepped Index Desk Expander

- Tough, long lasting polypropylene
- 13 compartment desk expander with carry handles for easy portability
- Can hold A4 punchless filing, brochures, documents and magazines
- Has unique stepped index, allowing tabs to be seen clearly

* Other products within this range are available



1.2mm
THICKNESS



SNOPAKE
5
YEARS
GUARANTEE

CODE	DESCRIPTION	TRADE PK	OUTER
15650	13-Part Desk Expander • Fusion Assorted	5 Organisers	8 Packs

Fusion Assorted: 1 x Indigo, Burgundy, Emerald, Smoke and Plum





-  x650
MAX SHEET CAPACITY
- 13-Part
-  x300
MAX SHEET CAPACITY
- 6-Part
-  0.92mm
THICKNESS
-  SNOPAKE
5 YEARS
GUARANTEE

THE ART OF PRESENTATION Expanding Organiser

- Manage projects in style with this slim, underarm organiser
- Large capacity 13-part model features a soft-feel handle
- Luxurious sewn edges with soft-touch trim
- Complete with index tabs printed in co-ordinating tones of graduated blue/grey

CODE	DESCRIPTION	TRADE PK	OUTER
13520	Foolscap 6-Part Organiser • Stellite Blue/Black	1 Organiser	30 Packs
13521	Foolscap 13-Part Organiser • Stellite Blue/Black	1 Organiser	15 Packs



-  x1250
MAX SHEET CAPACITY
- 13-Part
-  x300
MAX SHEET CAPACITY
- 6-Part
-  x1
BUSINESS CARD HOLDER
-  0.92mm
THICKNESS
-  SNOPAKE
5 YEARS
GUARANTEE

THE ART OF PRESENTATION FileCase

- Strong 24-part expanding file, holds 1250 sheets
- Manufactured in tough, stylish polypropylene
- Carry-handle and strong lock gives it a briefcase appearance
- Suitable for people on the move to keep records and reports organised

CODE	DESCRIPTION	TRADE PK	OUTER
13524	Foolscap 24-Part Expanding Organiser • Stellite Blue/Black	1 Organiser	10 Packs



-  x40
NUMBER OF SHEETS
-  PEN HOLDER
-  1mm
THICKNESS
-  SNOPAKE
5 YEARS
GUARANTEE

THE ART OF PRESENTATION MeetingMate

- Multi-use binder for conferences and meetings
- Choice of 2 or 4 ring models
- 6-part expanding organiser
- Quality notepad with 40 lined 80gsm pages
- Business card holder and pen loop

CODE	DESCRIPTION	TRADE PK	OUTER
15303	2-Ring • 25mm Capacity (2/25) • Stellite Black	1 File	12 Packs
14029	4-Ring • 25mm Capacity (4/25) • Stellite Blue/Black	1 File	12 Packs



-  x400
MAX SHEET CAPACITY
-  x4
HIDING SYSTEM
-  0.9mm
THICKNESS
-  SNOPAKE
5 YEARS
GUARANTEE

THE ART OF PRESENTATION ZipGrip 4-Part Organiser

- Sumptuous high quality document case with zip closure
- Integrated handle for comfort and portability
- Four generous-sized inner compartments for notes and papers
- Extra internal zip storage section for pens, business cards, phones and receipts

CODE	DESCRIPTION	TRADE PK	OUTER
14947	Foolscap 4-Part Organiser • Stellite Blue/Black	1 Organiser	20 Packs
15309	Foolscap 4-Part Organiser • Stellite Black	1 Organiser	20 Packs

Swordfish



tried & tested technology

What's so special about Swordfish products?

At Swordfish we like to keep things simple. That means simple to choose, simple to use, machines that simply get on with the job. We don't add complications – and cost – by adding unnecessary features, but we do use tried and tested technology that you can rely on. That's the core Swordfish philosophy.

Whether you are looking for a shredder, laminator, pencil sharpener, paper trimmer or electrical accessory, you will find that Swordfish offer a wide range of products, each with different characteristics, so there is bound to be one that meets your needs – exactly. Then we make it easy for you to choose the right product by publishing the most comprehensive set of specifications in the industry.

Nobody gives you more information than Swordfish. But again, we keep it simple. We don't baffle you with technical specifications – we tell you exactly what you need to know, such as the number of sheets a shredder can shred in an hour, or the actual time that each laminator takes to seal an A4 document. We even say which pencil sharpener gets the best results with different types of pencil.

Take a look at the product specification grids on pages 103-119 and you will see how simple it now is to choose the best product for your needs – and your budget.

When you come to use your new Swordfish machine, you will find that's simple, too. We provide simple, easy to follow instruction manuals and our machines have simple, easy to use controls. So – simple to use, simple to choose.

Simple machines that simply get the job done. That's Swordfish. But what happens when things go wrong? Fortunately, that doesn't happen very often. We go to great trouble to make sure that our products are designed for reliability and long life. That's why we are able to confidently offer a two-year guarantee across the Swordfish range. But should the worst happen, you'll find that our on-line warranty claim system is (at the risk of being repetitive) very simple. Because we want you to be up and running again as quickly as possible, with the minimum of fuss.

Swordfish. Making it easy by keeping things simple.



Brighten your workspace with smart design and exciting colours



Office machines don't have to be dull and boring! Bright, metallic colours and ground-breaking designs set these new signature products from Swordfish apart from the rest.

We have enlarged our range of coloured products with the introduction of two new Creative Trimmers in a distinctive purple and white livery. Our remarkable travel adaptors are now available in a greater choice of colours and we have expanded our popular range of pocket pencil sharpeners in vibrant, fashionable colours. Many of these new sharpeners, and the VariPlug travel adaptor, also have a soft-touch finish, so they don't just look good, they feel good, too.

tried & tested technology

PAPER SHREDDERS

Our Swordfish shredders, whether used at home or in the office, are the most secure and convenient way to dispose of your documents.

With the ever-growing concerns surrounding data security and fraud, you can never be too careful. Our fine-cut shredders ensure your confidentiality and protect your identity, while ensuring GDPR compliance.

From occasional use at home, to continuous use in the office, the different specifications and capabilities of Swordfish's shredder range make it easier to find the right shredder for you.

Swordfish micro-cut shredders offer the advantages of enhanced security and quiet operation.

A further benefit is that they cut so fine, their bins require less frequent emptying than cross-cut shredders.



Cross-Cut Shredders



600XC-P4 6-sheet Cross-Cut

- Cuts an A4 sheet into approx. 446 pieces
- Shreds approx. 160 sheets per hour
- Easy-lift head for simple, mess-free emptying
- Shreds credit cards and small staples
- Security rating P-4 + E-3 (see p.75)
- Recommended for sensitive & confidential data



Code: 40357



800XC-P4 8-sheet Cross-Cut

- Cuts an A4 sheet into approx. 446 pieces
- Shreds approx. 220 sheets per hour
- Easy-lift head for simple, mess-free emptying
- Shreds credit cards and small staples
- Security rating P-4 + E-3 (see p.75)
- Recommended for sensitive & confidential data



Code: 40361



800XC 8-sheet Cross-Cut

- Cuts an A4 sheet into approx. 400 pieces
- Shreds approx. 335 sheets per hour
- Easy-lift head for simple, mess-free emptying
- Shreds credit cards and small staples
- Security rating DIN P-4 + E-3 (see p.75)
- Recommended for sensitive & confidential data



Code: 40230



tried & tested technology



X-SECURIA 800XC

8-sheet Cross-Cut

- Cuts an A4 sheet into approx. 330 pieces
- Shreds approx. 370 sheets per hour
- Slide-out waste bin
- Shreds credit cards, paperclips and small staples
- Security rating DIN P-3 + E-2 (see p.75)
- Recommended for sensitive & confidential data



Code: 40300 



1000XC-P4 EL

10-sheet Cross-Cut

- Cuts an A4 sheet into approx. 446 pieces
- Shreds approx. 300 sheets per hour
- Easy-lift head for simple, mess-free emptying
- Security rating DIN P-4 + E-3 (see p.75)
- Recommended for sensitive & confidential data



Code: 40364 





1000XC 10-sheet Cross-Cut

- Cuts an A4 sheet into approx. 400 pieces
- Shreds approx. 600 sheets per hour
- Slide-out waste bin
- 4 castors for easy mobility
- Security rating DIN P-4 + E-3 (see p.75)
- Recommended for highly sensitive & confidential data



Code: 45009 



1000XC Plus 10-sheet Cross-Cut

- Cuts an A4 sheet into approx. 470 pieces
- Shreds approx. 555 sheets per hour
- Slide-out waste bin
- 4 castors for easy mobility
- Security rating DIN P-4 + E-3 (see p.75)
- Recommended for highly sensitive & confidential data



Code: 40347 



tried & tested technology



1000XCD 10-sheet Cross-Cut

- Cuts an A4 sheet into approx. 400 pieces
- Shreds approx. 450 sheets per hour
- Slide-out waste bin
- Shreds credit cards and small staples
- Destroys CDs/DVDs by embossing tiny dots on both sides
- 4 castors for easy mobility
- Security rating DIN P-4 + E-3 (see p.75)
- Recommended for highly sensitive & confidential data



Code: 45010

Space Saving Design



1400XCD 14-sheet Cross-Cut

- Cuts an A4 sheet into approx. 430 pieces
- Shreds approx. 2200 sheets per hour
- Slide-out waste bin
- Shreds credit cards, paperclips and small staples
- 4 castors for easy mobility
- Security rating DIN P-4 + E-3 + O-3 (see p.75)
- Recommended for highly sensitive & confidential data



Code: 40329



1500XCD 15-sheet Cross-Cut

- Cuts an A4 sheet into approx. 625 pieces
- Shreds approx. 900 sheets per hour
- Slide-out waste bin
- Shreds credit cards, CDs/DVDs and paperclips
- 4 castors for easy mobility
- Security rating DIN P-4 + E-3 + O-3 (see p.75)
- Recommended for highly sensitive & confidential data



Code: 45011 



Continuous Shredding
Without Overheating

1600XCD 16-sheet Cross-Cut

- Cuts an A4 sheet into approx. 400 pieces
- Shreds approx. 6500 sheets per hour
- Slide-out waste bin
- Shreds credit cards, CDs/DVDs, paperclips and small staples
- Security rating DIN level P-4 + E-3 + O-3 (see p.75)
- Recommended for highly sensitive & confidential data



Code: 40244 



tried & tested technology



Continuous Shredding
Without Overheating

2000XCD Plus
20-sheet Cross-Cut

- Cuts an A4 sheet into approx. 555 pieces
- Shreds approx. 6250 sheets per hour
- Slide-out waste bin
- Shreds credit cards, CDs/DVDs and small staples
- 4 castors for easy mobility
- Security rating DIN P-4 + E-3 + O-3 (see p.75)
- Recommended for highly sensitive & confidential data



Code: 40363



Continuous Shredding
Without Overheating

2400XCD
24-sheet Cross-Cut

- Cuts an A4 sheet into approx. 446 pieces
- Shreds approx. 6180 sheets per hour
- Slide-out waste bin
- Shreds credit cards, CDs/DVDs, paperclips and small staples
- 4 castors for easy mobility
- Security rating DIN P-4 + E-3 + O-3 (see p.75)
- Recommended for highly sensitive & confidential data



Code: 40366

Micro-Cut Shredders

Ultimate Security
for extremely sensitive data



600XXC 6-sheet Super Micro-Cut

- Cuts an A4 sheet into more than 6,237 pieces
- Shreds approx. 888 sheets per hour
- Slide-out waste bin
- Shreds small staples
- 4 castors for easy mobility
- Security rating P-5 (see p.75)
- Recommended for extremely sensitive & confidential data



Code: 40362



800XXC-P4 8-sheet Micro-Cut

- Cuts an A4 sheet into more than 1,560 pieces
- Shreds approx. 400 sheets per hour
- Slide-out waste bin
- 4 castors for easy mobility
- Security rating P-4 + E-3 (see p.75)
- Recommended for highly sensitive & confidential data



Code: 40348

tried & tested technology



800XXC-P5 8-sheet Micro-Cut

- Cuts an A4 sheet into more than 3,120 pieces
- Shreds approx. 800 sheets per hour
- Slide-out waste bin
- 4 castors for easy mobility
- Security rating DIN P-5 + E-4 (see p.75)
- Recommended for extremely sensitive data which needs to be kept secret



Code: 40158



1200XXCD 12-sheet Micro-Cut

- Cuts an A4 sheet into approximately 1,560 pieces
- New and improved, now with a duty cycle of 30mins
- Shreds approx. 4,000 sheets per hour
- Slide-out waste bin
- Shreds credit cards, CDs/DVDs, paperclips and small staples
- 4 castors for easy mobility
- Security rating DIN P-4 + E-3 + O-1 (see p.75)
- Recommended for highly sensitive & confidential data



Code: 40237



New & Improved!

Scan here to find out more about the 1200XXCD



Protect your data and ensure GDPR compliance by using Swordfish's tried & tested technology.

The General Data Protection Regulation replaces the EU's 1995 Data Protection Directive, and came into force on the **25th May 2018**.

It has been developed to strengthen and unify privacy rights and data protection for individuals within the European Union while streamlining the data protection obligations of businesses serving EU citizens through a single Regulation instead of 28 different National laws.

The Regulation requires organisations of all sizes to adopt a new set of processes and policies aimed at giving individuals greater control over their personal records and apply sound security practices to both electronic and paper-based data (failure to do so could result in massive fines of up to £20m or 4% of annual global revenue – whichever is greater.) Much of this will involve writing new processes and manuals, retraining staff and updating systems to accommodate these new procedures. Other steps involve practical measures, such as having a clear data protection and shredding policy.

By shredding documents, organisations reduce the risks of non-compliance and all the implications thereafter. The simplest way to think about protection is to ask if you are holding onto customer information. Be it paper records or data media such as CD-ROMs and Chip Cards, these are all potential areas where confidential information could be compromised.

Reducing sensitive paper documents into non-legible particles will lessen the risk of personal data breach. As shown in the table below paper shredding levels range from basic P-1 to the most secure P-7. The P-6 & P-7 levels tend to be used by government and defence sectors for the most confidential documents, however, commercial organisations are increasingly using P-4 & P-5 level shredders to reduce the risks of data breach. These shredders are capable of turning an A4 sheet into an incredible 400 & 2,000 separate tiny pieces.

Swordfish tried & tested shredders help you to protect the identity and confidentiality of your customers and dispose of your sensitive and confidential data in a secure manner while ensuring compliance to the paper security requirements of GDPR.

DIN 66399 security levels for paper documents, optical media and electronic data

Classification according to DIN 66399	PAPER		OPTICAL MEDIA		ELECTRONIC DATA CARRIERS	
	Class Level	Particle sizes according to DIN 66399	Class Level	Particle sizes according to DIN 66399	Class Level	State after destruction
... that the data on it can be reproduced without special tools or skills but not without a certain amount of time expenditure Recommended e.g. for Data Carriers containing general data which needs to be rendered illegible.	P-1	Material particle area max. 2,000mm ² or strip width max. 12.0mm strip length unlimited	O-1	Particle size max. 2000 mm ²	E-1	Medium mechanically / electronically inoperable
... that the data on it can be reproduced with tools and only with a certain degree of effort Recommended e.g. for Data Carriers containing internal data which needs to be rendered illegible	P-2	Material particle area max. 800mm ² or strip width max. 6.0mm strip length unlimited	O-2	Particle size max. 800 mm ²	E-2	Medium disintegrated
... that the data on it can be reproduced only with considerable effort (personnel, tools, time) Recommended e.g. for Data Carriers containing sensitive and confidential data	P-3	Material particle area max. 320mm ² or strip width max. 2.0mm strip length unlimited	O-3	Particle size max. 160 mm ²	E-3	Medium disintegrated and max. particle area 160mm ²
... that the data on it can only be reproduced using non commercially available or specially designed devices Recommended e.g. for Data Carriers containing highly sensitive and confidential data	P-4	Material particle area max. 160mm ² and for regular particles: max. strip width 6.0mm	O-4	Particle size max. 30 mm ²	E-4	Data carrier (chip) disintegrated and max. particle area 30mm ²
... that the data on it is unlikely to be reproduced given the current level of technology Recommended e.g. for Data Carriers containing data which needs to be kept secret	P-5	Material particle area max. 30mm ² and for regular particles: max. strip width 2.0mm	O-5	Particle size max. 10 mm ²	E-5	Data carrier (chip) variously destroyed and max. particle area 10mm ²

tried & tested technology



Prolong the life of your Shredder

As with all types of machinery, document shredders will not operate efficiently unless properly maintained. The most effective way to care for a shredder is to oil it regularly.

Oiling is an essential part of shredder maintenance. It helps to maintain maximum performance and is necessary in order to maintain warranty coverage.

Shredding produces a surprising amount of paper dust which builds up inside the cutting assembly. Without frequent oiling, the accumulated detritus compacts, putting strain on the cutters, motor, gears and bearings. Failing to oil a shredder will inevitably reduce its lifetime.

Shredders should be oiled on a regular basis and before any period of intensive shredding.

Lubrication should always be done when the shredder is cold. Never add oil to a hot shredder. Never use oil from an aerosol as the propellant may be flammable. Always use oil designed for use in shredders.

Swordfish Shredder Oil comes in two handy varieties to suit your model of shredder and the frequency at which it is likely to require oiling.



Scan here to find out more about lubricating your shredder



Shredder Lubricant Sachets

- Pack of 12 Sachets
- For use with all types of shredders



Code: 40015



Shredder Oil Lubricant 240ml & 350ml

- Special micro-dispenser
- 240ml for approximately 20 applications
- 350ml for approximately 30 applications
- For use with all types of shredders



Code: 40069 (240ml)
Code: 40240 (350ml)



LAMINATORS

Here today. Here tomorrow! Lamination protects documents by permanently encapsulating them between two sheets of plastic – the laminating pouch. This preserves the life of your document as once sealed, documents are protected against handling, water, grease and finger-marks. If your lamination becomes dirty, simply wipe it clean.

Whether a photograph, important presentation material or children's artwork, lamination will enhance the colour in the document, preserve it and make it more attractive.

To achieve a professional result, you can always count on Swordfish's high quality laminating pouches, available in a full range of thicknesses and sizes along with Swordfish's long lasting Laminating Pouch Carrier to laminate non-standard shapes, sizes or materials.

Swordfish range of laminators includes feature-rich models for all users, from hobbyists to professionals, capable of laminating documents up to A2 size, all designed to make lamination simple, straightforward and trouble-free.

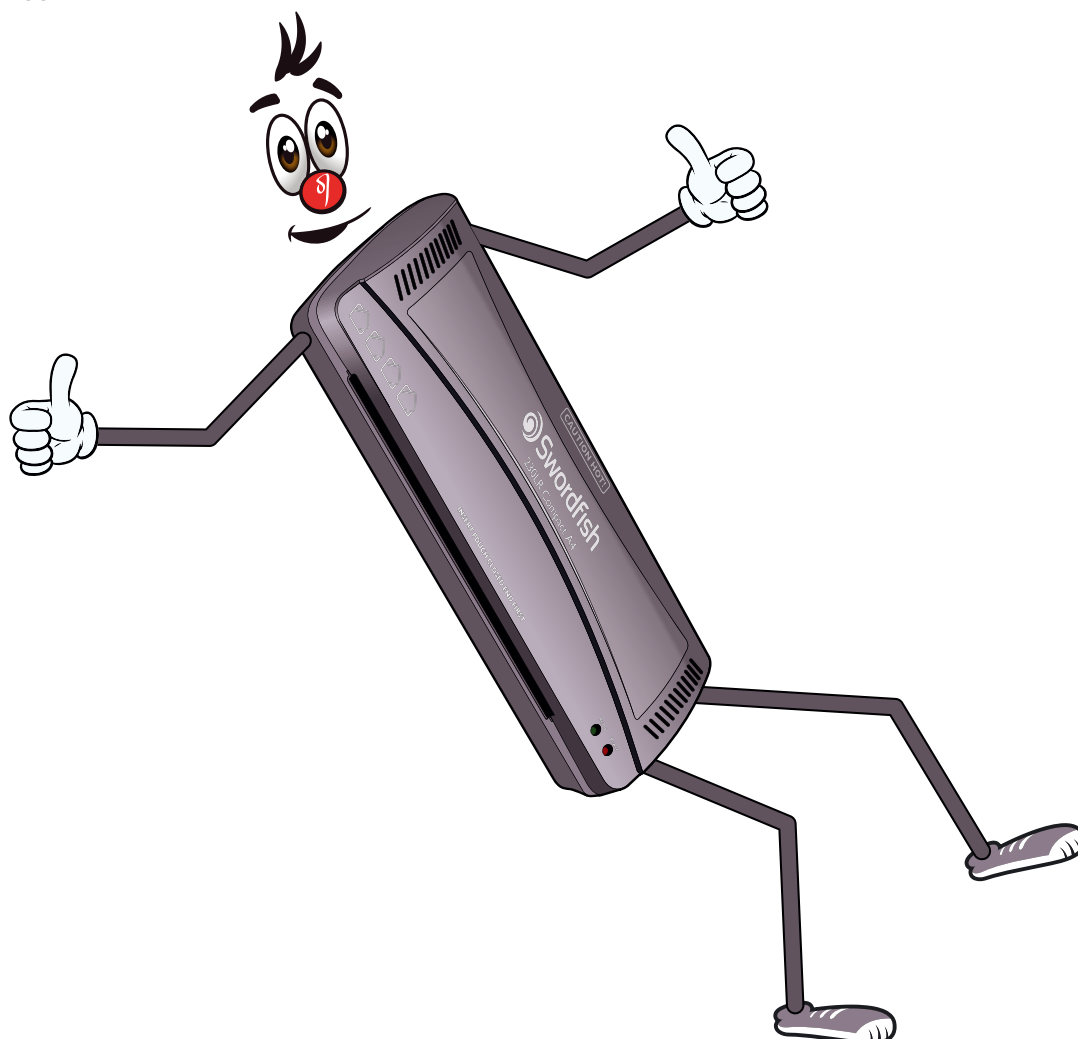

tried & tested technology

330LR Compact A3 Laminator



230LR Compact A4 Laminator



230LR Compact A4 & 330LR Compact A3 Home & Office Laminators

- Available in A4 and A3 sizes
- 230mm (230LR) and 330mm (330LR) laminating widths
- Laminates an A4 sheet in approx 1 min 20 secs
- 5 minutes warm up time
- Jam release function
- Cold lamination option



Code: (230LR) 40188 +

Code: (330LR) 40191 +



SuperSlim A4 Home & Office Laminators

- Available in A4 size in metallic red or blue
- 230mm laminating widths
- Laminates an A4 sheet in approx 1 min 25 secs
- 4 Roller technology
- 2-3 minutes warm up time
- Jam release function
- Cold lamination option



Code: ● 40186 +

Code: ● 40187 +





SuperFast A3 Office Laminator

- For documents up to A3 size
- 1 minute warm up time
- Laminates an A4 sheet in approx 27 secs
- Up to 800mm/min laminating speed
- Four roller technology for professional results
- Push button digital control for simple operation
- Cold lamination option
- Quiet operation
- Reverse Control

Code: 40368



TimeSaver² A3 Home & Small Office Laminator

- For documents up to A3 size
- Constant temperature, variable speed, technology
- 90 seconds warm up time
- Laminates an A4 sheet in approx 34 secs
- Up to 610mm/min laminating speed
- Four roller technology for professional results
- Push button digital control for simple operation
- Quiet operation
- Robust construction
- Audible and visual temperature indicators

Code: 40315



tried & tested technology



Armoured660 Heavy Duty A3 Professional Laminator

- For documents up to A3 size
- Rugged steel casing
- Laminates an A4 sheet in approx. 32 seconds
- Fast 660mm/min lamination
- Four large 25.6mm precision rollers
- 4-6 minutes warm up time
- Sophisticated temperature management
- Reverse Control

-
-
-
-

Code: 40352



Armoured660 Heavy Duty A2 Professional Laminators

- For documents up to A2 size
- Rugged steel casing
- Laminates an A4 sheet in approx. 32 seconds
- Fast 660mm/min lamination
- Four large 25.6mm precision rollers
- 4-6 minutes warm up time
- Sophisticated temperature management
- Reverse Control

-
-
-
-

Code: 40351



Armoured1000 Professional A2 Laminator

- For documents up to A2 size
- Rugged steel casing
- Laminates an A4 sheet in approx. 22 seconds
- Fast 1000mm/min lamination
- Four large 25.6mm precision rollers
- 4-6 minutes warm up time
- Sophisticated temperature management
- Reverse Control

Code: 40350



Laminating Pouches

2 x 75 [150] Micron Gloss Laminating Pouches
- Standard thickness for everyday protection

2 x 125 [250] Micron Gloss Laminating Pouches
- Greater thickness for enhanced protection

Scan here to find out more about Laminating



Description	Product Code	Thickness	No. of Pouches per box	Compatible with:
A4 Laminating Pouches 216 x 303mm	48017	2 x 75 [150] microns	100	All Swordfish Laminators
A4 Laminating Pouches 216 x 303mm	48021	2 x 125 [250] microns	100	All Swordfish Laminators

tried & tested technology

Armoured Pouch Carriers



- Available for documents in A4 and A3 sizes
- Superfine PTFE-coated woven glass fibre
- Thermally efficient for perfect heat transfer
- Essential when laminating cut-outs
- Durable and long-lasting
- Supplied in a robust storage tube - ideal for storage

Description	Product Code	Trade Pack	Outer Packs
A4 Armoured Pouch Carrier 230 x 343mm	40353	Pack of 1	50
A4 Armoured Pouch Carrier 230 x 343mm	40355	Pack of 5	10
A3 Armoured Pouch Carrier 320 x 480mm	40354	Pack of 1	50
A3 Armoured Pouch Carrier 320 x 480mm	40356	Pack of 5	10

Jammed pouches will cause frustration and can cause serious damage.

Lamination pouches need the support of paper across their entire area. If they do not have this support, the pouch can easily jam. If you want to laminate cut-outs, irregular shapes, undersized items, using a pouch carrier will help prevent jams and protect your laminator from damage.

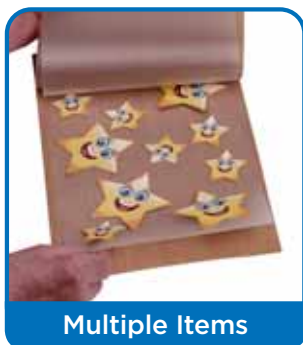

Multiple Items



Irregular Shapes



Undersized



Newspaper



Fabric

Scan to watch a problem-solving video



Here are some hints that will help you get the best results from your Swordfish Laminator

1

Set the machine to the correct temperature for the pouch in use. Pouches come in a range of thicknesses - the thickness of your pouches will be marked on their packaging.

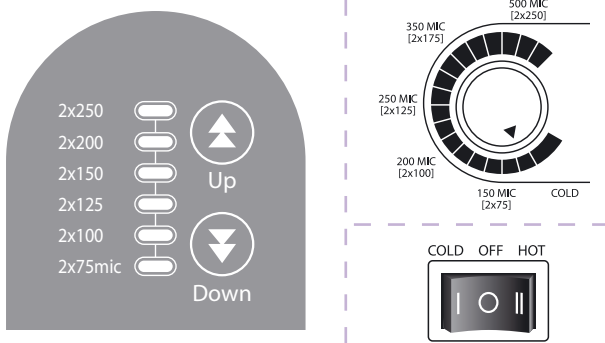

! Setting the temperature too low will produce poor lamination. Setting it too high could cause the pouch to jam in the machine.

2

Make sure that the item to be laminated completely fills the pouch, leaving **no more** than a 3mm border around the edges.

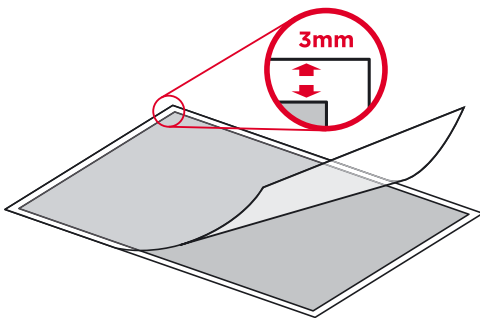

! Leaving a wider border can cause the pouch to jam because it needs to be supported across its entire area, as the heat in the machine could otherwise cause the pouch to soften and droop.

3

Laminators are designed to laminate paper or thin card.

! They are not suitable for fabric, tissue paper etc as soft materials provide insufficient support to the pouch.

4

Always insert a pouch closed end first into the laminator.

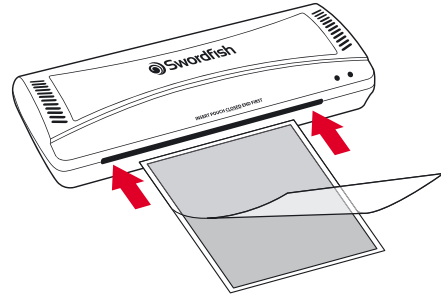

! If you put a pouch in open ended first, or sideways, you will almost inevitably cause the machine to jam!

5

Never attempt to laminate cut-outs, several small items within a larger pouch, leaves or organic materials, damp documents, stamps etc.

Make sure inkjet prints are completely dry before attempting to laminate them.

! Incompletely loaded pouches can cause a jam. If you absolutely need to laminate a collection of small items in one pouch, you must use a carrier.

Moisture in the paper being laminated will evaporate, causing the pouch to bubble.

6

If the item to be laminated is smaller than the available pouch, simply trim the pouch to size before feeding it into the machine.

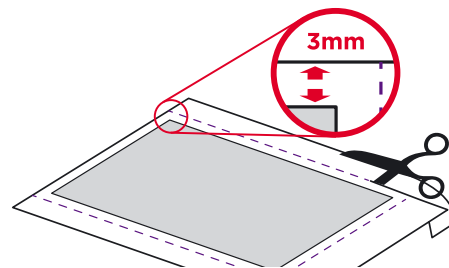

! To prevent jams always fill your pouch correctly leaving no more than a 3mm border around each edge.

tried & tested technology

7 Never attempt to laminate thermal prints or pictures produced with wax crayons.

 **The heat inside the laminator will have an adverse effect on temperature sensitive materials. The image on a thermal print will degrade, wax crayons will melt.**

8 Be aware that the surface of your laminating machine may become hot during use.

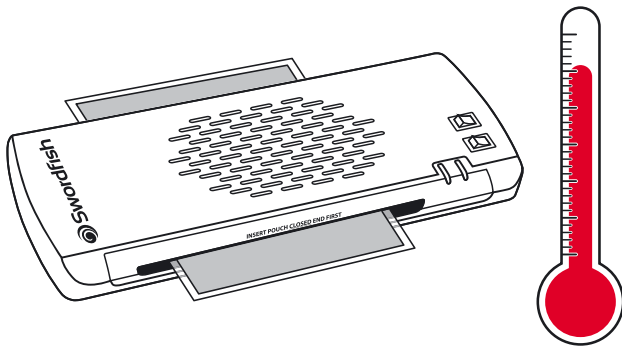

 **Children must have adult supervision. Take care.**

9 Make sure there is enough space behind the laminator to allow the pouch free passage through the machine.

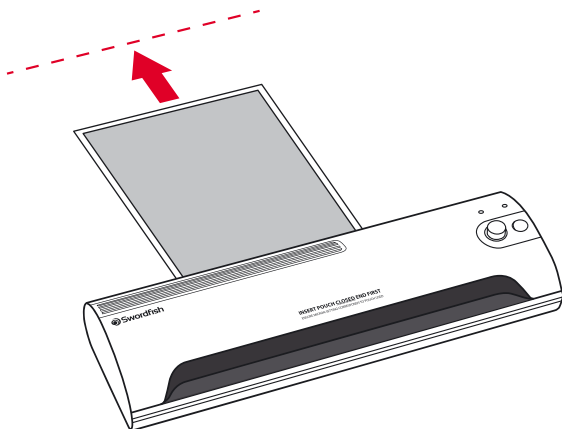

 **The laminated pouch will be warm as it exits the machine. It needs to cool down lying flat in order to avoid wrinkles.**

10 Never leave your laminator unattended whilst it is in use. Always watch to make sure that the pouch exits the machine. The leading edge of the pouch should start to emerge before the trailing edge enters the machine.

 **This check will enable you to release a jam, before it causes damage to the machine. We strongly recommend that you use Swordfish, or similar high-quality branded pouches, as inferior grade pouches give poor results and can cause permanent damage to your laminator.**

11 Simple maintenance on a regular basis will clean rollers by absorbing and surplus adhesive. We would suggest passing a piece of thin stiff card through the machine after every 10 laminations.

The side from your cereal packet would be ideal.

 **This regular maintenance will help prevent jams caused by sticky rollers.**

12 Allow the machine to cool down completely before attempting to move it.

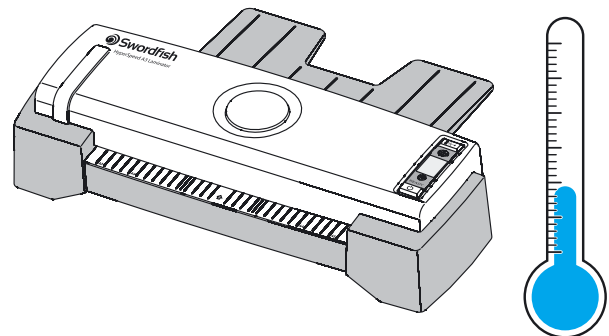

 **Failure to do so could cause serious damage to the machine.**

PENCIL SHARPENERS & ERASERS

From a small pocket sharpener to electric machines that can sharpen 15 pencils a minute, Swordfish are the experts. Our sharpeners have been designed to meet individual needs. Sharpeners that have their blades retained by tamper-proof screws are ideal for school kids, whilst electric sharpeners that can handle a variety of different pencil diameters are a boon to busy teachers. We even have a fully automatic, hands-free sharpener that takes the hard work out of sharpening lots of pencils.

Artists who use specialist pencils are pleased to see that we test all our mechanical and electric sharpeners on a range of these pencils – and publish the results, taking the guesswork out of choosing the right machine.

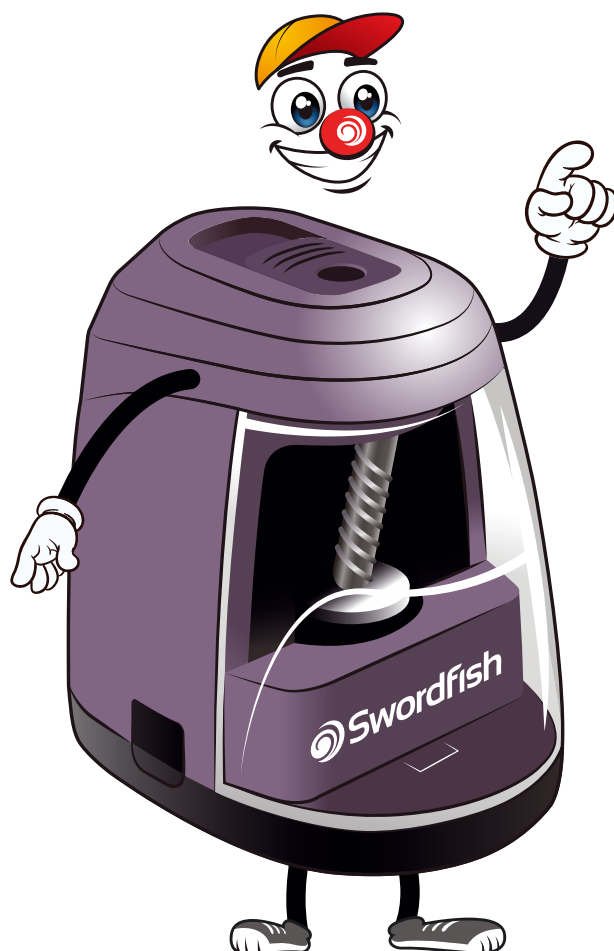

tried & tested technology



PVC & PHTHALATE FREE

- Non Toxic
- Latex Free

Pencil Top Eraser

- Neon colours
- Fits on top of a pencil snugly
- Eraser suitable for young children

Code: 40314 (12 B.Cards of 25)



PVC & PHTHALATE FREE

- Non Toxic
- Latex Free

Shielded Eraser

- Plastic eraser protector keeps the eraser clean
- The protector can rotate 360°
- Eraser suitable for young children

Code: ● 40283 (12 B.Cards of 2)
 Code: ● 40367 (12 B.Cards of 2)
 Code: ● ● ● 40312 (1 Tub of 36)



PVC & PHTHALATE FREE

- Non Toxic
- Latex Free

Large Soft Eraser

- Plastic Sleeve to help keep the eraser clean
- Erases a pencil drawing with less abrasion than a standard eraser
- Eraser suitable for young children

Code: 40277 Large (1 CDU of 20)
 Code: 40323 Large (1 Tub of 30)



PVC & PHTHALATE FREE

- Non Toxic
- Latex Free

Large Plastic Eraser

- Plastic Sleeve to help keep the eraser clean
- Eraser suitable for young children

Code: 40273 Large (1 CDU of 20)



- Non Toxic
- Latex Free

Marble Eraser

- Fun, ergonomic and aesthetically designed eraser
- Rounded corners ideal for efficient erasing
- Dip for more comfortable grip
- Clear sleeve to protect the eraser
- Eraser suitable for young children

Code: 40375* (1 CDU of 24)
Code: 40377 (12 B.Cards of 3)**

* Purple, Blue, Orange, Pink
 ** Blue, Orange, Pink



- Non Toxic
- Latex Free

Armadillo Eraser

- Clear bag to protect the eraser
- Fun, ergonomic and aesthetically designed eraser
- Can be personalised by changing the edge colours
- Eraser suitable for young children

Code: 40334 (1 Tub of 24)



- Non Toxic
- Latex Free

Stripey Eraser

- Fun, ergonomic and aesthetically designed eraser
- Striped colour all the way through the eraser
- 64mm long eraser
- Eraser suitable for young children

Code: 40336 (1 Tub of 24)



- Non Toxic
- Latex Free

Optik Eraser

- Fun, ergonomic and aesthetically designed eraser
- Eraser suitable for young children

Code: 40369 (1 CDU of 24)

tried & tested technology



PVC & PHTHALATE FREE

- Non Toxic
- Latex Free

Wedge Eraser

- Fun, ergonomic and aesthetically designed eraser
- Dotted finish for a comfortable grip
- Eraser suitable for young children

Code: 40372 (12 B.Cards of 2)
Code: 40373 (12 B.Cards of 2)



PVC & PHTHALATE FREE

- Non Toxic
- Latex Free

Wavez Eraser

- Fun, ergonomic and aesthetically designed eraser
- Plastic sleeve to help keep the Eraser clean
- Eraser suitable for young children

Code: 40374 (1 CDU of 36)



PVC & PHTHALATE FREE

- Non Toxic
- Latex Free

LineOut Ruler Eraser

- Fun, ergonomic and aesthetically designed eraser
- Multifunctional eraser encased in a 10cm/4 inch ruler
- Eraser suitable for young children

Code: 40370 (1 CDU of 24)



PVC & PHTHALATE FREE

- Non Toxic
- Latex Free

LineOut Mini Ruler Eraser

- Fun, ergonomic and aesthetically designed eraser
- Multifunctional eraser encased in a 5cm ruler
- Eraser suitable for young children

Code: 40371 (1 CDU of 24)



• Non Toxic
• Latex Free

Large Eraser & Pencil Sharpener

- Single hole for standard (8mm) diameter pencils
- Sharpener made from Zinc
- Large Plastic Eraser
- Plastic Sleeve to help keep the Eraser clean

Code: 40284 (12 B.Cards of 1)



• Non Toxic
• Latex Free

Combo Pencil Sharpener & Eraser

- Single hole for standard (8mm) diameter pencils
- Soft rubber edging for a comfortable grip
- Canister makes it mess-free
- Eraser has a lid to keep it protected
- Inset blade so no sharp edges accessible

Code: Turquoise 40294 (12 B.Cards of 1)
Code: Pink 40365 (12 B.Cards of 1)



• Non Toxic
• Latex Free

Twin Combo Pencil Sharpener & Eraser

- Double hole for standard (8mm) & large (10.5mm) diameter pencils
- Soft rubber edging for a comfortable grip
- Canister makes it mess-free
- Eraser has a lid to keep it protected
- Inset blades so no sharp edges accessible

Code: 40295 (1 CDU of 20)
Code: 40296 (12 B.Cards of 1)



• Non Toxic
• Latex Free

SpaceShip Combo Pencil Sharpener & Eraser

- Single hole for standard (8mm) diameter pencils
- Canister makes it mess-free
- Can spin on its axis
- Fun ergonomic and aesthetically designed eraser with white on the edge
- Inset blades so no sharp edges are accessible

Code: 40341 (1 CDU of 12)

tried & tested technology



Plastic Wedge Pencil Sharpeners

- Single hole for standard (8mm) diameter pencils
- Finger grip perfect for small hands
- Inset blade so no sharp edges are accessible

Code: 40024 (10 Header Bags of 10)
Code: 40259 (1 Box of 50)



Metal Wedge Pencil Sharpeners

- Single hole for standard (8mm) diameter pencils
- Double hole for standard (8mm) & large (10.5mm) diameter pencils
- Finger grip perfect for small hands
- Made from Aluminium

Code: 40210 (8mm, 1 Box of 20)
Code: 40212 (8 & 10.5 mm, 1 Box of 20)



Blinc Blinc Pencil Sharpener

- Available in Black
- Double hole for standard (8mm) & large (10.5mm) diameter pencils
- Made from Zinc
- Strong Metal Casing
- Inset blades so no sharp edges accessible

Code: 40285 (1 CDU of 12)
Code: 40286 (12 B.Cards of 1)



Canister Pencil Sharpener

- Single hole for standard (8mm) diameter pencils
- Double hole for standard (8mm) & large (10.5mm) diameter pencils
- Translucent canister for easy viewing
- Canister makes it mess-free
- Inset blades so no sharp edges accessible

Code: 40032 (Single-Hole, 1 CDU of 10)
Code: 40033 (Double-Hole, 1 CDU of 10)



Double Hole Click Pencil Sharpener

- Double hole for standard (8mm) & large (10.5mm) diameter pencils
- Made from Aluminium
- Transparent canister for easy viewing
- Canister makes it mess-free

Code: 40378 (12 B.Cards of 1)



Soft Grip Pencil Sharpener

- Single hole for standard (8mm) diameter pencils
- Soft rubber edging for a comfortable grip
- Fun ergonomic shape suitable for young children
- Inset blade so no sharp edges accessible

Code: 40179 (1 Tub of 36)
Code: 40287 (12 B.Cards of 2)



Twin Soft Grip Pencil Sharpener

- Double hole for standard (8mm) & large (10.5mm) diameter pencils
- Soft rubber edging for a comfortable grip
- Fun ergonomic shape suitable for young children
- Inset blades so no sharp edges accessible

Code: 40288 (1 Tub of 30)
Code: 40289 (12 B.Cards of 1)



Canister Flip Pencil Sharpener

- Double hole for standard (8mm) & large (10.5mm) diameter pencils
- Soft rubber edging for a comfortable grip
- Canister makes it mess-free
- Fun ergonomic shape suitable for young children
- Inset blade so no sharp edges accessible

Code: 40290 (1 CDU of 12)
Code: 40291 (12 B.Cards of 1)

tried & tested technology



Twin Inverta Pencil Sharpener

- Double hole for standard (8mm) & large (10.5mm) diameter pencils
- Translucent canister for easy viewing
- Turn canister over to have either 8mm or 10.5mm hole
- Canister makes it mess-free
- Fun ergonomic shape suitable for young children
- Inset blades so no sharp edges accessible

Code: 40271 (1 CDU of 12)



Beehive Pencil Sharpener

- Double hole for standard (8mm) & large (10.5mm) diameter pencils
- Canister makes it mess-free
- Fun, ergonomic shape suitable for young children
- Inset blade so no sharp edges accessible

Code: 40319 (1 Tub of 10)



Click Click Pencil Sharpener

- Single hole for standard (8mm) diameter pencils
- Small canister makes it mess-free
- Soft touch rubber canister
- Press button to reveal pencil sharpener

Code: 40320 (1 CDU of 16)
Code: 40331 (12 B.Cards of 1)
Code: 40332 (1 Tub of 12)



The Triple Pencil Sharpener

- Available in purple
- 3- hole canister for standard (8mm) & large (11mm) pencils & (16mm) crayons
- Translucent canister for easy viewing
- Canister makes it mess-free
- Inset blades so no sharp edges accessible

Code: 40228S (10 B.Cards of 1)
Code: 40228 (1 CDU of 10)



- INCLUDES DESK CLAMP
- AUTO STOP WHEN SHARP
- SWORDFISH 2 YEARS WARRANTY

Pointi Mechanical Pencil Sharpener

- Robust plastic construction
- High capacity shavings tray
- Compact design
- Auto stop when sharp to prevent oversharpening
- For standard 8mm diameter pencils
- Desk clamp included

Code: 40235



- REPLACEABLE HELICAL BLADE
- AUTO STOP WHEN SHARP
- INCLUDES DESK CLAMP
- SWORDFISH 2 YEARS WARRANTY

Ikon Mechanical Pencil Sharpener

- Strong replaceable helical blade
- Auto Stop when sharp to prevent oversharpening
- For standard (8mm) diameter pencils
- Space conscious compact design
- Desk clamp included

Code: 40100

Replacement Blade Code: 40908



- REPLACEABLE HELICAL BLADE
- AUTO STOP WHEN SHARP
- MULTIPLE SIZE
- PENCIL POINT OPTIONS
- INCLUDES DESK CLAMP
- SWORDFISH 2 YEARS WARRANTY

Curve Mechanical Pencil Sharpener

- Pencil point options for a rounded or sharp tip
- Strong replaceable helical blade
- Auto Stop when sharp to prevent oversharpening
- For standard (8mm) up to large (12mm) diameter pencils
- Desk clamp included

Code: 40103

Replacement Blade Code: 40807



- REPLACEABLE HELICAL BLADE
- AUTO STOP WHEN SHARP
- MULTIPLE SIZE
- PENCIL POINT OPTIONS
- INCLUDES DESK CLAMP
- SWORDFISH 2 YEARS WARRANTY

Scholar Mechanical Pencil Sharpener

- Pencil point options for a rounded or sharp tip
- Strong replaceable helical blade
- Auto Stop when sharp to prevent oversharpening
- For standard (8mm) up to large (12mm) diameter pencils
- Desk clamp included

Code: 40104

Replacement Blade Code: 40907

tried & tested technology



OmniPoint Mechanical Pencil Sharpener

- Pencil point options for a rounded or sharp tip
- Very large capacity shavings tray
- For standard (8mm) up to large (12mm) diameter pencils
- Desk clamp included

Code: 40305

Replacement Blade Code: 40306



Scribbler Battery-powered Pencil Sharpener

- Portable, compact and handy
- Automatically sharpens when pencil is inserted
- Safety feature cuts power when tray is removed
- Sharp blade sharpens in seconds
- For standard (8mm) diameter pencils
- Requires 4 x AA batteries (not supplied)

Code: 40003



VariPoint Mini Dual Power Pencil Sharpener

- For standard (8mm) diameter pencils
- Adjustable pencil points
- Auto Stop prevents over-sharpening
- Replaceable blade unit
- Safety off feature when tray is removed
- Powered by USB cable (inc.) or 4 x AA batteries (not inc.)
- Sharpens up to 6 pencils per minute

Code: 40304



MiniPro Dual Power Pencil Sharpener

- For standard (8mm) diameter pencils
- Professional helical blade
- Battery or USB power
- Slow-running gives great results with soft pencils
- Compact footprint
- Safety off feature when shaving tray is removed

Code: 40245



Fusion² Dual Power Pencil Sharpener

- Battery or mains operated
- Pencil point sharpness selector - from blunt to sharp
- Broken tip removal button
- Safety feature cuts power when the shavings tray is removed
- Strong, sharp helical blade
- For standard (8mm) and large (10mm) diameter pencils
- Option of 6 volt PSU (Power Supply Unit) included or 4xAA batteries (not supplied) for portability

Code: 40309



VertiPoint Electric Pencil Sharpener

- Vertical design for easy one-handed sharpening
- Strong, sharp helical blade
- Fast 7-second sharpening
- Double safety interlock
- Large capacity shavings tray
- Small footprint saves desk space
- For standard (8mm)diameter pencils
- Complete with 9 Volt power supply unit

Code: 40310

Replacement Blade Code: 40311



VariPoint Electric Pencil Sharpener

- Strong replaceable helical blade
- Auto-stop when sharp to prevent oversharpenering
- Safety feature cuts power when tray is removed
- Pencil point options for a rounded or sharp tip
- For standard 8mm diameter pencils

Code: 40232

Replacement Blade Code: 40236



tried & tested technology



MultiPoint Electric Pencil Sharpener

- Strong replaceable helical blade
- Sharpens up to 10 pencils per minute
- Auto-stop when sharp to prevent oversharping
- Safety feature cuts power when tray is removed
- Four second sharpening
- For standard 6, 7, 8, 9, 10 & 11mm diameter pencils

Code: 40233

Replacement Blade Code: 40234



Contour Electric Pencil Sharpener

- Choice of pencil point options from rounded to sharp
- Sharpens up to 6 pencils per minute
- Automatically sharpens when a pencil is inserted and stops when it is removed
- Auto-stop when sharp to prevent oversharping
- Safety feature cuts power when tray is removed
- Effective thermal cut-out to protect the motor
- A jam eject button enables broken leads to be removed with ease.
- For standard (8mm) diameter pencils

Code: 40051

Replacement Blade Code: 40806



Sketch Electric Pencil Sharpener

- Automatically sharpens when a pencil is inserted and stops when it is removed
- Sharpens up to 12 pencils per minute
- Auto-stop when sharp to prevent oversharping
- Safety feature cuts power when tray is removed
- Effective thermal cut-out to protect the motor
- Strong, sharp replaceable helical blade
- Suitable for all types of pencil
- For standard (8mm) diameter pencil

Code: 40050

Replacement Blade Code: 40805





Trio Electric Pencil Sharpener

- For standard 8mm, 9.5mm and 11mm diameter pencils
- Automatically sharpens when a pencil is inserted and stops when it is removed
- Sharpens up to 15 pencils per minute
- Auto-stop when sharp to prevent oversharping
- Safety feature cuts power when tray is removed
- Effective thermal cut-out to protect the motor
- Strong, sharp replaceable helical blade
- Robust plastic body and capacious shavings tray

Code: 40906

Replacement Blade Code: 40023



Latitude Electric Pencil Sharpener

- Automatically sharpens when a pencil is inserted and stops when it is removed
- Sharpens up to 15 pencils per minute
- Auto-stop when sharp to prevent oversharping
- Safety feature cuts power when tray is removed
- Effective thermal cut-out to protect the motor
- Strong, sharp replaceable helical blade
- For standard 8mm diameter pencils

Code: 40052

Replacement Blade Code: 40802



AutoFeed Electric Pencil Sharpener

- Auto-feed and auto-eject when sharp
- Broken point ejector
- Variable point selector
- Pencil hole safety shutter
- Shavings tray with safety interlock
- Strong, sharp replaceable blade
- For standard 8mm diameter pencils

Code: 40327

AutoFeed Service Kit: 40328



PAPER TRIMMERS

Rotary paper trimmers have largely replaced old-fashioned guillotines – and for good reason.

Trimmers are easier to use, more accurate and most importantly, safer.

It is virtually impossible for a user to cut their finger whilst using a trimmer. The only time that a trimmer blade is exposed is when it is being changed, when appropriate caution should be used.

Rotary trimmers have many applications, so the Swordfish range has been developed to meet all needs, from the home craft worker to busy offices, schools and studios and everything in between. Available in sizes ranging from A4 up to A2, Swordfish has a paper trimmer for all your cutting needs.

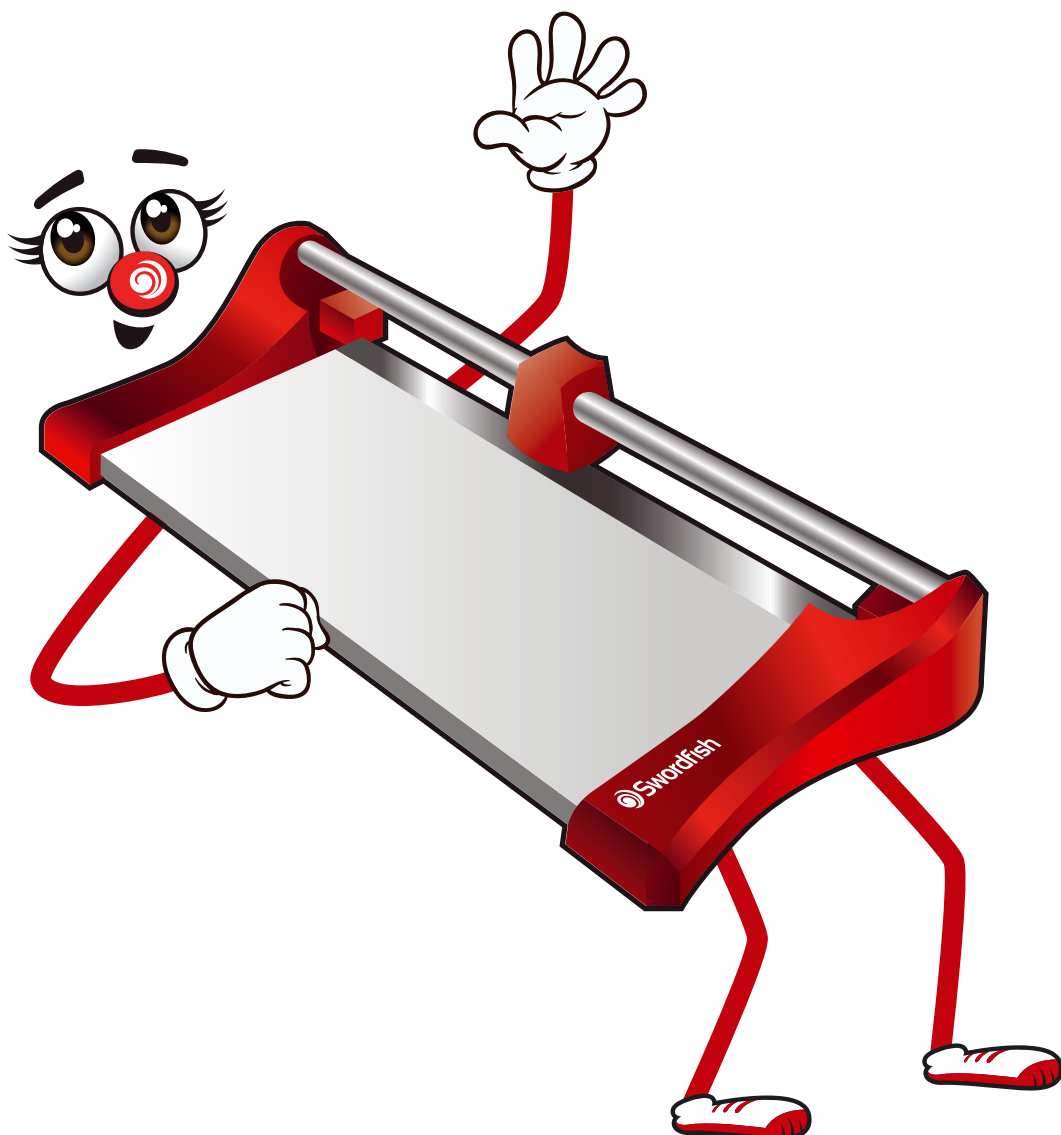



3 in 1 Creative Trimmer

- 3 different types of trim: straight, perforated and wave
- For paper and light card
- Rotating module for easy blade selection
- No exposed blades



Code: 40342



UP TO 5 SHEETS



UP TO 3 SHEETS



UP TO 3 SHEETS



5 in 1 Creative Trimmer

- 5 different types of trim: straight, perforated, wave, score and round corners
- For paper and light card
- Rotating thumbwheel for easy blade selection
- No exposed blades



Code: 40343



UP TO 8 SHEETS



UP TO 5 SHEETS



UP TO 5 SHEETS



UP TO 5 SHEETS



Replacement Head Code: 40344

Replacement Cutting Strip (Pk3) Code: 40346

Replacement Corner Trimmer Code: 40345



tried & tested technology



A3 SlimLine Trimmer

- UP TO A3 SIZE
- CUTS UP TO 10 SHEETS
- CARBON STEEL BLADE
- 450mm CUT LENGTH
- SWORDFISH 2 YEARS WARRANTY



A4 SlimLine Trimmer

- UP TO A4 SIZE
- CUTS UP TO 10 SHEETS
- CARBON STEEL BLADE
- 320mm CUT LENGTH
- SWORDFISH 2 YEARS WARRANTY



A3 & A4 SlimLine 10-sheet Trimmers

- Available in A3 & A4 sizes in metallic red, blue and purple
- Cuts up to 10 sheets of 80gsm paper
- Easy to store and carry
- Cuts in one smooth movement
- Produces a clean, straight cut
- Smart, slim design

Code: (A4) ● 40262 ● 40263 ● 40359
 Code: (A3) ● 40260 ● 40261 ● 40358

Replacement Cutting Head for Blue Trimmers
 Code: ● 40265
 Replacement Cutting Head for Red Trimmers
 Code: ● 40264
 Replacement Cutting Head for Purple Trimmers
 Code: ● 40360



Edge-320 A4 Trimmer

A3 & A4 Edge Series 10-sheet Trimmers

- Cut up to 10 sheets of 80gsm paper
- Strong metal base with non-slip rubber feet
- Long-lasting blade
- Paper formats printed on base to aid alignment



Code: (Edge-320 A4) 42013X
Code: (Edge-450 A3) 42014X

Replacement Cutting Head for Edge Series Trimmers
 Code: 40909X



Elite-670 A2 Trimmer

A2 & A3 Elite Series Professional Trimmers

- A3 cuts up to 15 sheets and A2 cuts up to 12 sheets of 80gsm paper
- Replaceable carbon steel rotary blade
- Strong metal base with non-slip rubber feet
- Paper formats printed on base to aid alignment



Code: (Elite-480 A3) 40058X
Code: (Elite-670 A2) 40087X

Replacement Cutting Head for Elite Series Trimmers
 Code: 40059X



tried & tested technology

Precision Cutting

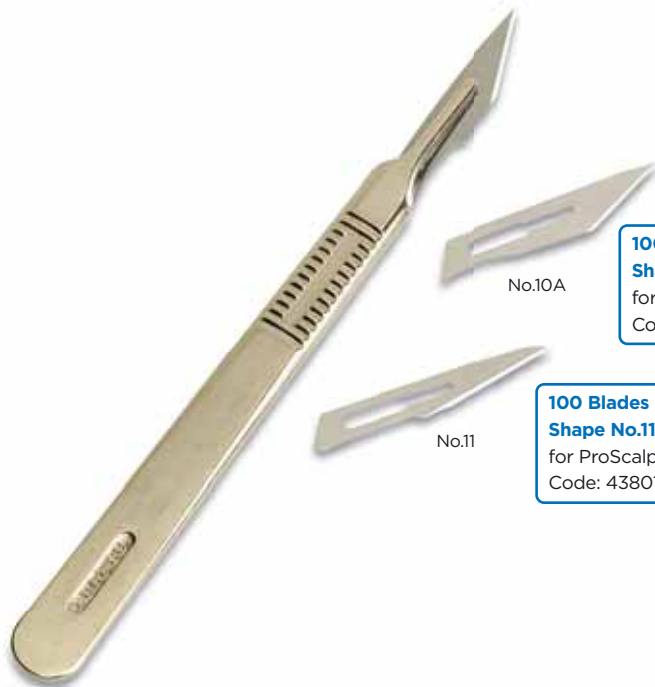

100 Blades
Shape No.10A
for ProScalpel
Code: 43802

100 Blades
Shape No.11
for ProScalpel
Code: 43801

ProScalpel

Handle and Blades

- Surgical quality No. 3 scalpel handle
- The professional's choice for fine, accurate cutting
- Supplied complete with 1 x No.10, 2 x No.10A & 1 x No.11 blades
- Replacement blades available in boxes of 100

Code: 43110



ELECTRICAL ACCESSORIES

Tablets and smartphones have ushered in a real revolution in portable communications. But these power-hungry devices need frequent charging. If you find that you never seem to have enough sockets to power all your essential electrical appliances and your smartphone, we have the answer - the Swordfish **VariPower** range.

Each product is designed to do a different job, but all have one thing in common - they are all equipped with high-output USB ports, so you no longer need to plug a charger into a socket - you simply connect a USB lead, leaving your sockets free.

Whether at home, in the office or on the move, the **VariPower** range is the easy way to power your life

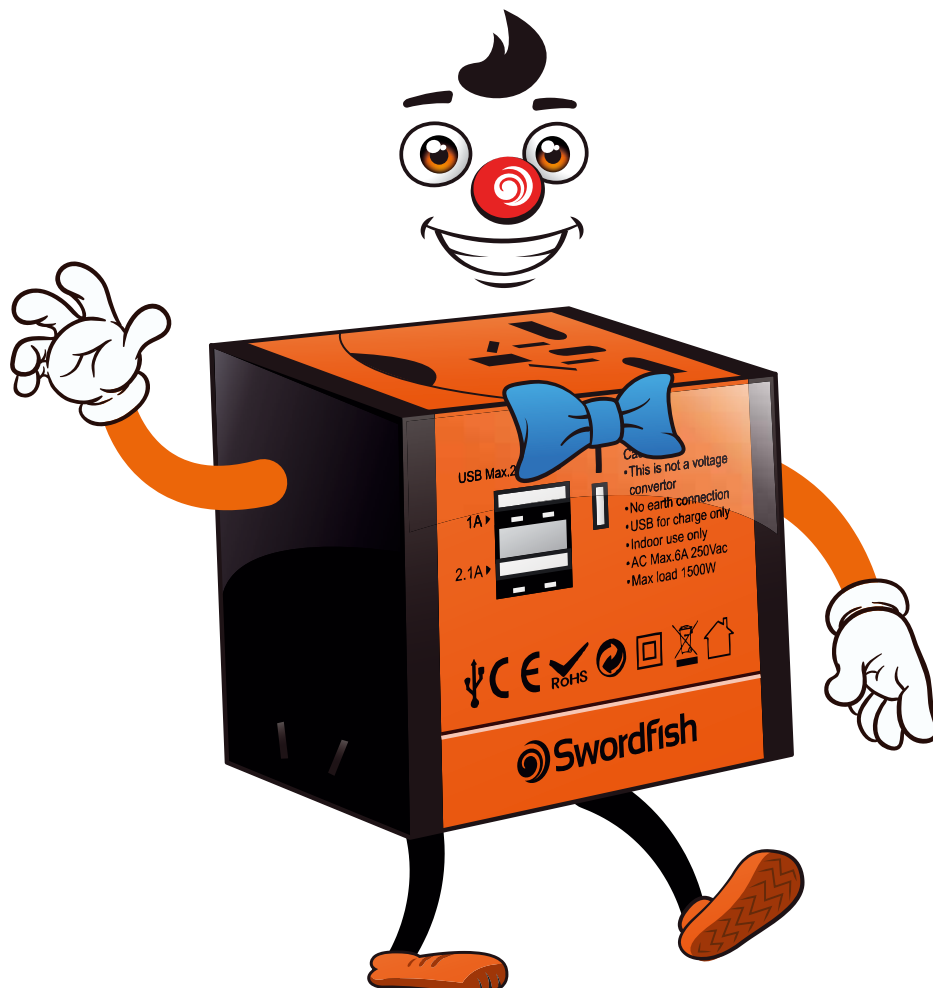

tried & tested technology

Power
3 Devices
at once



VariPlug Dual USB Universal Travel Adapter

- Easy to carry adapter with soft touch finish
- Get connected in over 150 countries worldwide
- Universal Socket
- 2100mA USB Output - Dual USB for charging two USB devices simultaneously e.g. Tablets & Smartphones
- 6A Fuse to protect from over-loading, over current and short circuit



NEW & IMPROVED!

Code: ● 40249
● 40255
● 40253

ACCOMMODATES THESE PLUGS...



Code: ● 40247
● 40248
● 40254
● 40330

ACCOMMODATES THESE PLUGS...



SUITABLE FOR USE WITH...





Power 8 Devices at once

VariSocket 4

Surge Protected Power Board

- 4 x USB charging ports delivering 4000mA
- 4 x surge protected 13A sockets
- 2m cable
- Equipped with safety shutters
- Port level protection
- Individual on/off switch

- x4** 13amp SOCKETS
- x4** USB CHARGING PORTS
- 2m** CABLE LENGTH
- 2** YEARS WARRANTY
- SAFETY SHUTTERS
- TAMPER-RESISTANT SCREW
- SWORDFISH

SUITABLE FOR USE WITH...



Code: 40313



Power 10 Devices at once

VariSocket 6

Surge Protected Power Board

- 4 x USB charging ports delivering 4000mA
- 6 x surge protected 13A sockets
- 2m cable
- Equipped with safety shutters
- Port level protection
- Individual on/off switch

- x6** 13amp SOCKETS
- x4** USB CHARGING PORTS
- 2m** CABLE LENGTH
- 2** YEARS WARRANTY
- SAFETY SHUTTERS
- TAMPER-RESISTANT SCREW
- SWORDFISH

SUITABLE FOR USE WITH...











Code: 40317

tried & tested technology









SWORDFISH PRODUCT SPECIFICATIONS











	600XC-P4 6-Sheet Cross-Cut	800XC-P4 8-Sheet Cross-Cut	800XC 8-Sheet Cross-Cut	X-Securia 800XC White 8-Sheet Cross-Cut
				
Suitability				
	Home	Home	Home	Home
What makes it special?	Low Cost - High Security!	Low Cost - High Security!	Effective, Efficient & Economical	Security with style
Swordfish UK Product Code	40357	40361	40230	40300
UK Barcode (for individual unit)	5019118010387	5019118010455	5019118007578	5019118009213
Cut Type	Cross	Cross	Cross	Cross
Particle Size (mm)	4 x 35	4 x 35	4 x 39	5 x 38
Paper Security Level DIN	P - 4	P - 4	P - 4	P - 3
Credit Card Security Level DIN	E - 3	E - 3	E - 3	E - 2
CD/DVD Security Level DIN	n/a	n/a	n/a	n/a
GDPR Compliant	✓	✓	✓	✓
Approx. no. of pieces A4 page shredded into	446	446	400	330
Cutting Capacity (80gsm)	6 sheets	8 sheets	8 sheets, 75gsm 7 sheets, 80gsm	8 sheets
Feed Entry Width (mm)	220	220	225	220
Speed (m/minutes)	2.0	2.0	2.2	2.25
Noise Level	72dB	72dB	72dB	68dB
Duty Cycle ON (minutes)	2	2	2	3
Duty Cycle OFF (minutes)	45	45	15	40
Approx no. of sheets per Duty Cycle	80	110	118	185
Approx no. of sheets per hour	160	220	335	370
Bin Size (litres)	11.0	15.0	14	10
Approx. Bin Size (sheets)	65	115	110	50
Waste Bin Type	Easy-lift Head	Easy-lift Head	Easy-lift Head	Slide Out
Separate CD Waste Bin	X	X	X	X
Full Bin Indicator	X	X	X	X
LCD Display / Indicator Panel	X	X	X	X
Reverse Function	✓	✓	✓	✓
Auto Start / Stop Control	✓	✓	✓	✓
Credit Card Destroyer?	✓	✓	✓	✓
CD/DVD Destroyer?	X	X	X	X
Staples?	✓	✓	✓	✓
Paperclip Destroyer?	X	X	X	✓
Castors?	X	X	X	X
Weight (kg)	3.3	3.8	4	4.30
Product Dimensions H x W x D (mm)	350 x 330 x 155	350 x 313 x 195	350 x 301 x 195	360 x 195 x 337
Product Warranty	2 years	2 years	2 years	2 years
Cutter Warranty	2 years	2 years	2 years	2 years

tried & tested technology

	1000XC-P4 EL 10-Sheet Cross-Cut	1000XC 10-Sheet Cross-Cut	1000XC Plus 10-Sheet Cross-Cut	1000XCD 10-Sheet Cross-Cut	1400XCD 14-Sheet Cross-Cut
Suitability					
	Home	Home & Small Office	Home & Small Office	Home & Small Office	Home & Small Office
What makes it special?	Low Cost - High Security	Stylish & robust	Modern & space saving design	Space saving design	Stylish & robust
Swordfish UK Product Code	40364	45009	40347	45010	40329
UK Barcode (for individual unit)	5019118010547	5019118000715	5019118010240	5019118000722	5019118009756
Cut Type	Cross	Cross	Cross	Cross	Cross
Particle Size (mm)	4 x 35	4 x 39	4 x 33	4 x 39	4 x 36
Paper Security Level DIN	P - 4	P - 4	P - 4	P - 4	P - 4
Credit Cards Security Level DIN	E - 3	E - 3	E - 3	E - 3	E - 3
CD/DVD Security Level DIN	n/a	n/a	n/a	n/a	O - 3
GDPR Compliant	✓	✓	✓	✓	✓
Approx. no. of pieces A4 page shredded into	446	400	470	400	430
Cutting Capacity (80gsm)	10 sheets	10 sheets	10 sheets	10 sheets	14 sheets
Feed Entry Width (mm)	220	220	220	222	220
Speed (m/minutes)	2.0	2.0	1.8	1.5	2.4
Noise Level	72dB	69dB	69dB	69dB	58dB
Duty Cycle ON (minutes)	2	3	3	3	10
Duty Cycle OFF (minutes)	45	20	30	20	40
Approx. no. of sheets per Duty Cycle	150	200	185	150	1130
Approx. no. of sheets per hour	300	600	555	450	2260
Bin Size (litres)	21.0	20.0	19.0	17.1	22
Approx. Bin Size (sheets)	180	155	170	140	240
Waste Bin Type	Easy-lift Head	Slide Out	Slide Out	Slide Out	Slide Out
Separate CD Waste Bin	X	X	X	X	X
Full Bin Indicator	X	X	X	X	X
LCD Display / Indicator Panel	X	X	X	X	✓
Reverse Function	✓	✓	✓	✓	✓
Auto Start / Stop Control	✓ Infrared	✓ Infrared	✓	✓ Infrared	✓
Credit Card Destroyer?	✓	✓	✓	✓	✓
CD/DVD Destroyer?	X	X	X	✓	✓
Staples?	✓	✓	✓	✓	✓
Paperclip Destroyer?	X	X	X	X	X
Castors?	X	✓	✓	✓	✓
Weight (kg)	5.05	8.1	6.95	9.3	11.1
Product Dimensions H x W x D (mm)	600 x 455 x 345	533 x 350 x 262	470 x 350 x 240	477 x 264 x 371	590 x 354 x 269
Product Warranty	2 years	2 years	2 years	2 years	2 years
Cutter Warranty	2 years	2 years	2 years	2 years	2 years

	1500XCD 15-Sheet Cross-Cut	1600XCD 16-Sheet Cross-Cut	2000XCD Plus 20-Sheet Cross-Cut	2400XC 24-Sheet Cross-Cut
				
Suitability				
	Home & Small Office	Small Office & Office	Small Office & Office	Office
What makes it special?	High capacity, intelligent security	Continuous shredding, minimalist design	High Security - Whisper Quiet - Heavy Duty	High Capacity, Heavy Duty, High Security
Swordfish UK Product Code	45011	40244	40363	40366
UK Barcode (for individual unit)	5019118000739	5019118007844	5019118010486	5019118010554
Cut Type	Cross	Cross	Cross	Cross
Particle Size (mm)	4 x 25	4 x 39mm	4 x 28mm	4 x 35
Paper Security Level DIN	P - 4	P - 4	P - 4	P-4
Credit Card Security Level DIN	E - 3	E - 3	E - 3	E-3
CD/DVD Security Level DIN	O - 3	O - 3	O - 3	O-3
GDPR Compliant	✓	✓	✓	✓
Approx. no. of pieces A4 page shredded into	625	400	555	446
Cutting Capacity (80gsm)	15 sheets	16 sheets	20 sheets	24 sheets
Feed Entry Width (mm)	220	222	220	220
Speed (m/minutes)	2.0	1.5 - 2.4	1.55	1.5 - 2.0
Noise Level	65dB	57 - 66dB	60dB	62dB
Duty Cycle ON (minutes)	3	60	60	30
Duty Cycle OFF (minutes)	20	40	40	9
Approx no. of sheets per Duty Cycle	300	6,500	6,250	3636
Approx no. of sheets per hour	850	6,500	6,250	6180
Bin Size (litres)	30.0	29	29.0	30.0
Approx. Bin Size (sheets)	615	410	600	610
Waste Bin Type	Slide Out	Slide Out	Slide Out	Slide Out
Separate CD Waste Bin	X	X	X	X
Full Bin Indicator	✓	✓	✓	✓
LCD Display / Indicator Panel	X	X	X	X
Reverse Function	✓	✓	✓	✓
Auto Start / Stop Control	✓ Infrared	✓	✓ Infrared	✓
Credit Card Destroyer?	✓	✓	✓	✓
CD/DVD Destroyer?	✓	✓	✓	✓
Staples?	✓	✓	✓	✓
Paperclip Destroyer?	✓	✓	X	✓
Castors?	✓	✓	✓	✓
Weight (kg)	14.9	12.3	17.3	16.75
Product Dimensions H x W x D (mm)	640 x 396 x 323	517 x 400 x 300	550 x 393 x 283	622 x 410 x 320
Product Warranty	2 years	2 years	2 years	2 years
Cutter Warranty	2 years	2 years	2 years	2 years

tried & tested technology

	600XXC 6-Sheet Super Micro-Cut	800XXC-P4 8-Sheet Micro-Cut	800XXC-P5 8-Sheet Micro-Cut	1200XXCD 12-Sheet Micro-Cut
				
Suitability	 Home & Small Office	 Home & Small Office	 Home & Small Office	 Small Office & Office
What makes it special?	Extremely Secure & Whisper Quiet	Modern & Space Saving Design	Whisper quiet & extra secure	Whisper quiet & extra secure
Swordfish UK Product Code	40362	40348	40158	40237
UK Barcode (for individual unit)	5019118010530	5019118010295	5019118005659	5019118007721
Cut Type	Super Micro	Micro	Micro	Micro
Particle Size (mm)	2 x 5mm	4 x 10	2 x 12	4 x 10
Paper Security Level DIN	P - 5	P - 4	P - 5	P - 4
Credit Card Security Level DIN	n/a	E - 3	E - 4	E - 3
CD/DVD Security Level DIN	n/a	n/a	n/a	O - 1
GDPR Compliant	✓	✓	✓	✓
Approx. no. of pieces A4 page shredded into	6237	1,560	2,600	1,560
Cutting Capacity (80gsm)	6 sheets	8 sheets	8 sheets	12 sheets
Feed Entry Width (mm)	220	220	225	220
Speed (m/minutes)	2.2	2.5	2.0	3.3
Noise Level	58dB	69dB	55dB	50dB
Duty Cycle ON (minutes)	10	3	10	30
Duty Cycle OFF (minutes)	40	30	45	40
Approx. no. of sheets per Duty Cycle	444	200	530	4,000
Approx. no. of sheets per hour	888	400	800	4,000
Bin Size (litres)	15.0	19.0	17.0	26.0
Approx. Bin Size (sheets)	425	250	280	650
Waste Bin Type	Slide Out	Slide Out	Slide Out	Slide Out
Separate CD Waste Bin	x	x	x	✓
Full Bin Indicator	x	x	x	✓
LCD Display / Indicator Panel	x	x	x	x
Reverse Function	✓	✓	✓	✓
Auto Start / Stop Control	✓	✓	✓ Infrared	✓
Credit Card Destroyer?	x	✓	✓	✓
CD/DVD Destroyer?	x	x	x	✓
Staples?	✓	✓	✓	✓
Paperclip Destroyer?	x	x	✓	✓
Castors?	✓	✓	✓	✓
Weight (kg)	8	6.9	10	15.6
Product Dimensions H x W x D (mm)	520 x 340 x 250	470 x 350 x 240	540 x 346 x 248	534 x 376 x 286
Product Warranty	2 years	2 years	2 years	2 years
Cutter Warranty	2 years	2 years	2 years	2 years

	230LR A4 Compact Laminator	330LR A3 Compact Laminator	SuperSlim A4 Laminator	SuperSlim A4 Laminator
				
Suitability				
	Home & Small Office	Home & Small Office	Home & Small Office	Home & Small Office
Why?	Compact & efficient	Compact & efficient	Fast warm up - great results	Fast warm up - great results
Swordfish UK Product Code	40188	40191	40186	40187
UK Barcode (for trade pack only)	5019118006762	5019118006823	5019118006724	5019118006748
Maximum Paper Size	A4	A3	A4	A4
Colour	Dark Silver	Dark Silver	Red	Blue
Feed Entry Width (mm)	230	330	230	230
Maximum Pouch Thickness	2 x 125 (250) Microns	2 x 125 (250) Microns	2 x 125 (250) Microns	2 x 125 (250) Microns
Maximum Pouch Thickness Total (mm)	0.6	0.6	0.6	0.6
Jam Release	✓	✓	✓	✓
Reverse Control	x	x	x	x
Cold Lamination Option	✓	✓	✓	✓
Auto Shut - Off	x	x	x	x
Number of Rollers	2	2	4	4
Warm-up Time (minutes)	5	5	2 - 3	2 - 3
Speed* (time to laminate an A4 sheet)	Approx 1 min 20 secs	Approx 1 min 20 secs	Approx 1 min 25 secs	Approx 1 min 25 secs
Product Dimensions H x W x D (mm)	62 x 350 x 145	62 x 440 x 145	36 x 390 x 170	36 x 390 x 170
Weight (kg)	1.23	1.53	1.41	1.41
Product Warranty (years)	2 years	2 years	2 years	2 years

*Based on using a 2 x 75 micron pouch with 80gsm copy paper

tried & tested technology

	SuperFast A3 Laminator	TimeSaver ² A3 Laminator	Armoured660 A3 Laminator	Armoured660 A2 Laminator	Armoured1000 A2 Laminator
					
Suitability					
	Home & Small Office	Home & Small Office	Small Office & Office	Small Office & Office	Small Office & Office
Why?	Swift warm-up, fast lamination	Quick warm up - fast lamination	High speed, heavy duty	High speed, heavy duty	SuperFast speed, heavy duty
Swordfish UK Product Code	40368	40315	40352	40351	40350
UK Barcode (for trade pack only)	5019118010608	5019118009374	5019118010288	5019118010271	5019118010264
Maximum Paper Size	A3	A3	A3	A2	A2
Colour	Black/Silver-Grey	Silver	Black/Silver-Grey	Black/Silver-Grey	Black/Silver-Grey
Feed Entry Width (mm)	340	335	320	450	450
Maximum Pouch Thickness	2 x 125 (250) Microns	2 x 150 (300) Microns	2 x 250 (500) Microns	2 x 250 (500) Microns	2 x 250 (500) Microns
Maximum Pouch Thickness Total (mm)	0.6	0.8	1.0	1.0	1.2
Jam Release	✓	✗	✓	✓	✓
Reverse Control	✓	✓	✓	✓	✓
Cold Lamination Option	✓	✓	✓	✓	✓
Auto Shut - Off	✓	✓ After 10 Mins	✗	✗	✓ After 30 Mins
Number of Rollers	4	4	4	4	4
Warm-up Time (minutes)	1 Min	Approx 1 Min 30 Secs	4 - 6 Mins	4 - 6 Mins	4 - 6 Mins
Speed* (time to laminate an A4 sheet)	Approx 27 Secs	Approx 34 Secs	Approx 32 Secs	Approx 32 Secs	Approx 22 Secs
Product Dimensions H x W x D (mm)	83 x 506 x 160	90 x 495 x 185	110 x 520 x 220	113 x 631 x 215	110 x 670 x 300
Weight (kg)	2.8	3.6	8.0	12.0	22.0
Product Warranty (years)	2 years	2 years	2 years	2 years	2 years

*Based on using a 2 x 75 micron pouch with 80gsm copy paper

	Pencil Top Eraser	Shielded Eraser	Shielded Eraser	Shielded Eraser	Large Soft Eraser	Large Soft Eraser
						
Swordfish UK Product Code	40314	40367	40283	40312	40277	40323
UK Barcode (for Trade Pack)	5019118009428	5019118010585	5019118008759	5019118009404	5019118008537	5019118009589
Trade Pack Packaging	12 Blisters of 25	12 Blisters of 2	12 Blisters of 2	1 Tub of 36	1 CDU of 20	1 Tub of 30
Pencil Size (mm)	N/A	N/A	N/A	N/A	Large	Large
Colour	N/A	N/A	N/A	N/A	N/A	N/A
Weight of Trade Pack (g)	800	725	725	890	625	830
Dimensions of pack H x L x D (mm)	168 x 179 x 83	133 x 78 x 305	133 x 78 x 305	140 x 140 x 135	28 x 133 x 118	140 x 140 x 135

	Large Plastic Eraser	Marble Eraser	Marble Eraser	Armadillo Eraser	Stripey Eraser	Optik Eraser
						
Swordfish UK Product Code	40273	40375	40377	40334	40336	40369
UK Barcode (for Trade Pack)	5019118008391	5019118010837	5019118010875	5019118009909	5019118009954	5019118010653
Trade Pack Packaging	1 CDU of 20	1 CDU of 24	12 Blisters of 3	1 Tub of 24	1 Tub of 24	1 CDU of 24
Pencil Size (mm)	Large	N/A	N/A	N/A	N/A	N/A
Colour	N/A					
Weight of Trade Pack (g)	625	555	950	800	970	500
Dimensions of pack H x L x D (mm)	28 x 133 x 118	34 x 125 x 110	170 x 85 x 100mm	132 x 128 x 111	133 x 128 x 111	32 x 150 x 100

tried & tested technology

	Wedge Eraser	Wedge Eraser	Wavez Eraser	LineOut Ruler Eraser	LineOut Mini Ruler Eraser	Large Eraser & Single Zinc Sharpener
Swordfish UK Product Code	40372	40373	40374	40370	40371	40284
UK Barcode (for Trade Pack)	5019118010752	5019118010776	5019118010622	5019118010684	5019118010721	5019118008780
Trade Pack Packaging	12 Blisters of 2	12 Blisters of 2	1 CDU of 36	1 CDU of 24	1 CDU of 24	12 Blisters of 1
Pencil Size (mm)	N/A	N/A	N/A	N/A	N/A	8
Colour						
Weight of Trade Pack (g)	500	500	370	710	385	415
Dimensions of pack H x L x D (mm)	165 x 123 x 80	165 x 123 x 80	56 x 165 x 103	46 x 130 x 130	93 x 120 x 130	133 x 78 x 155

	Combo Sharpener & Eraser	Combo Sharpener & Eraser	Twin Combo Sharpener & Eraser	Twin Combo Sharpener & Eraser	Spaceship Combo Sharpener & Eraser
Swordfish UK Product Code	40294	40365	40295	40296	40341
UK Barcode (for Trade Pack)	5019118009091	5019118010509	5019118009121	5019118009169	5019118010127
Trade Pack Packaging	12 Blisters of 1	12 Blisters of 1	1 CDU of 20	12 Blisters of 1	1 CDU of 12
Pencil Size (mm)	8	8	8 and 10.5	8 and 10.5	8
Colour					
Weight of Trade Pack (g)	486	486	826	608	860
Dimensions of pack H x L x D (mm)	133 x 78 x 195	133 x 78 x 195	195 x 202 x 80	133 x 78 x 280	80 x 260 x 190

	Single Plastic Wedge Pocket Pencil Sharpener	Single Plastic Wedge Pocket Pencil Sharpener	Single Metal Wedge Pocket Pencil Sharpener	Double Metal Wedge Pocket Pencil Sharpener	Blinc Blinc Pocket Pencil Sharpener	Blinc Blinc Pocket Pencil Sharpener
Swordfish UK Product Code	40024	40259	40210	40212	40285	40286
UK Barcode (for Trade Pack)	5019118002320	5019118554454	5019118001965	5019118520855	5019118008810	5019118008841
Trade Pack Packaging	10 Header bags of 10	Bulk Box of 50	Bulk Box of 20	Bulk Box of 20	1 CDU of 12	12 Blisters of 1
Pencil Size (mm)	8	8	8	8 and 10.5	8 and 10.5	8 and 10.5
Colour						
Weight of Trade Pack (g)	311	112	90	186	540	383
Dimensions of pack H x L x D (mm)	80 x 180 x 85	25 x 135 x 85	10 x 112 x 80	15 x 123 x 103	154 x 116 x 18	133 x 78 x 150

	Single hole Canister Pocket Pencil Sharpener	Double hole Canister Pocket Pencil Sharpener	Double Hole Click Pencil Sharpener	Soft Grip Pocket Pencil Sharpener	Soft Grip Pocket Pencil Sharpener	Twin Soft Grip Pocket Pencil Sharpener
Swordfish UK Product Code	40032	40033	40378	40179	40287	40288
UK Barcode (for Trade Pack)	5019118002580	5019118002610	5019118010905	5019118006526	5019118008872	5019118008902
Trade Pack Packaging	1 CDU of 10	1 CDU of 10	12 Blisters of 1	1 Tub of 36	12 Blisters of 2	1 Tub of 30
Pencil Size (mm)	8	8 and 10.5	8 and 10.5	8	8	8 and 10.5
Colour						
Weight of Trade Pack (g)	255	255	300	300	235	465
Dimensions of pack H x L x D (mm)	66 x 200 x 80	66 x 200 x 80	133 x 78 x 365	92 x 105 x 105	133 x 78 x 150	130 x 125 x 125

tried & tested technology

	Twin Soft Grip Pocket Pencil Sharpener	Canister Flip Pocket Pencil Sharpener	Canister Flip Pocket Pencil Sharpener	Twin Inverta Pocket Pencil Sharpener	Beehive Pocket Pencil Sharpener
Swordfish UK Product Code	40289	40290	40291	40271	40319
UK Barcode (for Trade Pack)	5019118008933	5019118008964	5019118008995	5019118008322	5019118009497
Trade Pack Packaging	12 Blisters of 1	1 CDU of 12	12 Blisters of 1	1 CDU of 12	1 CDU of 10
Pencil Size (mm)	8 and 10.5	8 and 10.5	8 and 10.5	8 and 10.5	8
Colour					
Weight of Trade Pack (g)	307	260	267	660	325
Dimensions of pack H x L x D (mm)	133 x 78 x 230	82 x 234 x 150	133 x 78 x 365	65 x 145 x 110	136 x 138 x 115

	Click Click Pocket Pencil Sharpener	Click Click Pocket Pencil Sharpener	Click Click Pocket Pencil Sharpener	'The Triple' - 3-hole Canister Pocket Pencil Sharpener	'The Triple' - 3-hole Canister Pocket Pencil Sharpener
Swordfish UK Product Code	40320	40331	40332	40228	40228S
UK Barcode (for Trade Pack)	5019118009527	5019118009848	5019118009862	5019118007417	5019118010462
Trade Pack Packaging	1 CDU of 16	12 B.Cards of 1	1 Tub of 12	1 CDU of 10	10 B.Cards of 1
Pencil Size (mm)	8	8	8	8, 11 and 16	8, 11 and 16
Colour					
Weight of Trade Pack (g)	340	450	330	385	385
Dimensions of pack H x L x D (mm)	156 x 156 x 60	220 x 175 x 145	140 x 135 x 140	69 x 148 x 222	100 x 170 x 210

	Pointi Mechanical Pencil Sharpener	Ikon Mechanical Pencil Sharpener	Curve Mechanical Pencil Sharpener	Scholar Mechanical Pencil Sharpener	OmniPoint Mechanical Pencil Sharpener
Suitability					
	Home	Home & Small Office	Small Office & Office	Small Office & Office	Home & Small Office
Why?	Budget-priced	Compact & efficient	Engineered to last	Stylish, versatile & robust	Combining capability & capacity
Swordfish UK Product Code	40235	40100	40103	40104	40305
UK Barcode (for individual unit)	5019118007677	5019118000906	5019118001552	5019118000777	5019118009268
Packaging	Box of 1	Box of 1	Box of 1	Box of 1	Box of 1
Swordfish Euro Product Code	—	—	—	—	—
Euro Barcode (for individual unit)	—	—	—	—	—
Pencil Size (mm)	8	8	8 - 12	8 - 12	8 - 12
Colours					
Blade Type	Helical (non-replaceable)	Helical (replaceable)	Helical (replaceable)	Helical (replaceable)	Helical (replaceable)
Replaceable Blade Code	—	40908	40807	40907	40306
Replaceable Blade Barcode	—	5019118001927	5019118100958	5019118001910	5019118009732
Time to sharpen one pencil (seconds)	—	—	—	—	—
No. of new pencils sharpened per minute	—	—	—	—	—
Noise Level	—	—	—	—	—
Shavings Tray Capacity (pencils)	15	20	50	44	35
Pencil Sharpening Angle (degrees)	11	19	20	20	20
Auto Stop	✓	✓	✓	✓	✓
Desk Clamp	✓	✓	✓	✓	✓
Pencil Point Options	X	X	✓	✓	✓
Jam Eject Button	X	X	X	X	X
Safety Cut Out	X	X	X	X	X
Auto On/Off	X	X	X	X	X
Weight inc pack (g)	220	277	388	674	433
Dimensions of pack H x W x D (mm)	105x115x65	95 x 100 x 95	100 x 132 x 100	126 x 115 x 86	115 x 125 x 90
Product Warranty (years)	2 years	2 years	2 years	2 years	2 years
Pencil Point results achieved using Swordfish Mechanical & Electrical Sharpeners					
Pencil Point Score - Graphite *	5	5	5	4.5	4
Pencil Point Score - Crayon *	4	5	5	4.5	4
Pencil Point Score - Charcoal *	Not Suitable	3	5	4	4
Pencil Point Score - Watercolour *	5	4.5	4.5	4	4
Pencil Point Score - Pastel **	4	5	4	4.5	4

*Pencil points score 0 - 5 (5 is best) for quality of point and wood finish

**Please note that pastel pencils are much more abrasive than graphite pencils and can cause sharpener blades to require frequent replacement

***Please also note that woodfire & wopax type pencils are much denser than natural wood pencils and will cause rapid wear to sharpener blades

tried & tested technology

	Scribbler Battery-powered Pencil Sharpener	VariPoint Mini Dual Power Pencil Sharpener	MiniPro Dual Power Pencil Sharpener	Fusion ² Dual Power Pencil Sharpener	VertiPoint Electric Pencil Sharpener	VariPoint Electric Pencil Sharpener
Suitability						
	Home	Home	Home & Small Office	Home & Small Office	Home & Small Office	Home/ Small Office/ Office and Ideal for Schools
Why?	Portable, compact & handy	Powered by battery or USB	Dual power / Helical blade	Versatile & Variable	Easy & Reliable	Heavy duty pencil point options
Swordfish UK Product Code	40003	40304	40245	40309	40310	40232
UK Barcode (for individual unit)	5019118002368	5019118009244	5019118007851	5019118009312	5019118009343	5019118007615
Packaging	Box of 1	Box of 1	Box of 1	Box of 1	Box of 1	Box of 1
Swordfish Euro Product Code	—	—	—	—	—	—
Euro Barcode (for individual unit)	—	—	—	—	—	—
Pencil Size (mm)	8	8	8	8 & 10	8	8
Colours						
Blade Type	Standard (non-replaceable)	Flat (replaceable)	Helical (non-replaceable)	Helical (non-replaceable)	Helical (replaceable)	Helical (replaceable)
Replaceable Blade Code	—	40303	—	—	40303	40234
Replaceable Blade Barcode	—	5019118009817	—	—	5019118009817	5019118007653
Time to sharpen one pencil (seconds)	—	10	15	15	6	3
No. of new pencils sharpened per minute	—	6	4	4	8	12
Noise Level	—	68dB	67dB	65dB	68dB	70dB
Shavings Tray Capacity (pencils)	7	8	15	10	15	10
Pencil Sharpening Angle (degrees)	20	14	14	20	20	10
Auto Stop	X	✓	X	✓	✓	✓
Desk Clamp	X	X	X	X	X	X
Pencil Point Options	X	✓	X	✓	X	✓
Jam Eject Button	X	X	X	X	X	X
Safety Cut Out	✓	✓	✓	✓	✓	✓
Auto On/Off	✓	✓	✓	✓	✓	✓
Weight inc pack (g)	145	273	315	414	345	730
Dimensions of pack H x W x D (mm)	80 x 75 x 70	87 x 67 x 80	120 x 135 x 80	110 x 165 x 80	195 x 102 x 75	115x200x88
Product Warranty (years)	2 years	2	2	2	2	2
Pencil Point results achieved using Swordfish Mechanical & Electrical Sharpeners						
Pencil Point Score - Graphite *	5	4	5	4	5	5
Pencil Point Score - Crayon *	4	4	5	5	4	4
Pencil Point Score - Charcoal *	2	4	5	Not Suitable	4	Not Suitable
Pencil Point Score - Watercolour *	4	4	5	5	4	5
Pencil Point Score - Pastel *	Not Suitable	Not Suitable	5	4	Not Suitable	Not Suitable

*Pencil points score 0 - 5 (5 is best) for quality of point and wood finish

**Please note that pastel pencils are much more abrasive than graphite pencils and can cause sharpener blades to require frequent replacement

***Please also note that woodfire & wopax type pencils are much denser than natural wood pencils and will cause rapid wear to sharpener blades

	MultiPoint Electric Pencil Sharpener	Contour Electric Pencil Sharpener	Sketch Electric Pencil Sharpener	Trio Electric Pencil Sharpener	Latitude Electric Pencil Sharpener	AutoFeed Electric Pencil Sharpener
Suitability						
	Home/ Small Office/ Office and Ideal for Schools	Home & Small Office	Home & Small Office	Small Office & Office	Small Office & Office	Small Office & Office
Why?	Fast & Versatile	Variable & efficient	Stylish & durable	Versatile & intelligent	Robust, efficient & powerful	Fully automatic
Swordfish UK Product Code	40233	40051	40050	40906	40052	40327
UK Barcode (for individual unit)	5019118007639	5019118002108	5019118002009	5019118003983	5019118002203	5019118809701
Packaging	Box of 1	Box of 1	Box of 1	Box of 1	Box of 1	Box of 1
Swordfish Euro Product Code	—	40049	40053	40047	40048	—
Euro Barcode (for individual unit)	—	5019118002894	5019118002917	5019118002849	5019118002870	—
Pencil Size (mm)	6,7,8,9,10 & 11	8	8	8, 9.5 and 11	8	8
Colours						
Blade Type	Helical (replaceable)	Helical (replaceable)	Helical (replaceable)	Helical (replaceable)	Helical (replaceable)	Helical (replaceable)
Replaceable Blade Code	40234	40806	40805	40023	40802	40328
Replaceable Blade Barcode	5019118007653	5019118002160	5019118003358	5019118002269	5019118001941	5019118009763
Time to sharpen one pencil (seconds)	4	6 - 11	5 - 6	4	4 - 6	12
No. of new pencils sharpened per minute	10	6	12	15	15	4
Noise Level	70dB	76dB	80dB	85dB	81dB	62dB
Shavings Tray Capacity (pencils)	10	23	36	76	36	15
Pencil Sharpening Angle (degrees)	14	17	17	20	17	20
Auto Stop	✓	✓	✓	✓	✓	✓
Desk Clamp	X	X	X	X	X	X
Pencil Point Options	X	✓	X	X	X	✓
Jam Eject Button	X	✓	X	X	X	✓
Safety Cut Out	✓	✓	✓	✓	✓	✓
Auto On/Off	✓	✓	✓	✓	✓	✓
Weight inc pack (g)	1330	125	140	195	160	1004
Dimensions of pack H x W x D (mm)	117x166x155	190 x 165 x 120	170 x 165 x 125	295 x 165 x 132	240 x 125 x 95	115 x 182 x 124
Product Warranty (years)	2	2	2	2	2	2
Pencil Point results achieved using Swordfish Mechanical & Electrical Sharpeners						
Pencil Point Score - Graphite *	4	5	4	2	4.5	5
Pencil Point Score - Crayon *	4	5	5+	4	5+	5
Pencil Point Score - Charcoal *	4	3	4	4	4	5
Pencil Point Score - Watercolour *	4	5	5	4	5	5
Pencil Point Score - Pastel *	4	4	5	4	5	4













*Pencil points score 0 - 5 (5 is best) for quality of point and wood finish

**Please note that pastel pencils are much more abrasive than graphite pencils and can cause sharpener blades to require frequent replacement

***Please also note that woodfire & wopax type pencils are much denser than natural wood pencils and will cause rapid wear to sharpener blades

tried & tested technology

	3 in 1 Creative Trimmer	5 in 1 Creative Trimmer	Red A4 SlimLine Trimmer	Blue A4 SlimLine Trimmer	Purple A4 SlimLine Trimmer	Red A3 SlimLine Trimmer
Suitability						
	Home	Home	Home & Small Office	Home & Small Office	Home & Small Office	Home & Small Office
Why?	Ideal for all paper-crafting projects	Ideal for all paper-crafting projects	Compact & stylish	Compact & stylish	Compact & stylish	Compact & stylish
Swordfish UK Product Code	40342	40343	40262	40263	40359	40260
UK Barcode (for individual unit)	5019118010141	5019118010165	5019118008100	5019118008124	5019118010394	5019118008063
Maximum Paper Size	A4	A4	A4	A4	A4	A3
Cutting Length (mm)	300	320	320	320	320	450
Cutting Capacity (mm)	0.5	0.8	1.0	1.0	1.0	1.0
Sheet Capacity (80gsm)	5	8	10	10	10	10
Replacement Cutting Head Code	n/a	40344 40345 40346	40264	40265	40360	40264
Replacement Cutting Head Barcode	n/a	5019118010189 5019118010202 5019118010226	5019118008148	5019118008162	5019118010431	5019118008148
Product Dimensions H x W x D inc box (mm)	78 x 460 x 34	105 x 510 x 97	200 x 452 x 77	200 x 452 x 77	200 x 452 x 77	200 x 574 x 77
Weight inc Box (kg)	0.19	0.655	1.0	1.0	1.0	1.17
Product Warranty (years)	1 year	2 years	2 years	2 years	2 years	2 years

	Blue A3 SlimLine Trimmer	Purple A3 SlimLine Trimmer	Edge-320 A4 10-Sheet Trimmer	Edge-450 A3 10-Sheet Trimmer	Elite-480 A3 15-Sheet Trimmer	Elite-670 A2 15-Sheet Trimmer
						
Suitability						
	Home & Small Office	Home & Small Office	Home & Small Office	Home & Small Office	Small Office & Office	Small Office & Office
Why?	Compact & stylish	Compact & stylish	Accurate & effortless cutting	Accurate & effortless cutting	High performance with style	High performance with style
Swordfish UK Product Code	40261	40358	42013X	42014X	40058X	40087X
UK Barcode (for individual unit)	5019118010417	5019118008087	5019118007431	5019118007455	5019118007516	5019118007530
Maximum Paper Size	A3	A3	A4	A3	A3	A2
Cutting Length (mm)	450	450	320	450	480	670
Cutting Capacity (mm)	1.0	1.0	1.0	1.0	1.5	1.5
Sheet Capacity (80gsm)	10	10	10	10	15	12
Replacement Cutting Head Code	40265	40360	40909X	40909X	40059X	40059X
Replacement Cutting Head Barcode (for trade pack only)	5019118008162	5019118010431	5019118007479	5019118007479	5019118003051	5019118003051
Product Dimensions H x W x D inc box (mm)	200 x 574 x 77	200 x 574 x 77	205 x 480 x 70	205 x 610 x 70	460 x 775 x 165	430 x 930 x 170
Weight inc Box (kg)	1.17	1.17	1.17	1.50	5.80	6.95
Product Warranty (years)	2 years	2 years	2 years	2 years	2 years	2 years

 **Platignum**
LONDON 1919



THE HISTORY of the pen is our history

Your handwriting says a lot about you – and so does the pen you hold. That's why over a century's experience as pen pioneers has led us to create this distinctive range of quality pens.

From the self-filling ranges we manufactured in 1919, we invented the world's first replacement nib, created the retractable ball-point in 1950 and introduced the first cartridge system.

We've been writing the history of the pen for generations and are continuing to innovate for the future.

ISN'T IT NICE TO BE ABLE TO HOLD HISTORY IN YOUR HAND?

1919

Platignum Pen Co. changes the world of pens with the self-filling, gold plated nib fountain pen.



1925

A revolution in pen design – the world's first replacement nib.



1939-1945

Platignum supports the war effort, commissioned by the MOD to create 'spy' pens concealing maps and compasses.



1950

Another breakthrough – the company invents the retractable ball point.



1962

The seminal Good Handwriting pen is introduced.



1965-1998

Platignum introduces the ink cartridge to the UK and becomes synonymous with education for over 30 years.



1992-2005

Platignum produces a collection of calligraphy sets to complement its traditional writing range.



2007

The Platignum Fine Writing brand is relaunched.



2011

Platignum's new signature style is born.



2012

Platignum decreased its packaging to reduce its carbon footprint & be more environmentally friendly.



2016

Tixx range launched.



2020

New S-Tixx range launched.



S-Tixx ✓

These S-Tixx Ball Point pens offer the ultimate writing experience. Their triangular and soft grip barrels ensures great comfort when writing. Combined with LV ink, which dries quickly to avoid smudges, these pens are perfect for both left and right handed writers.

- Disposable ball point pen
- LV ink - smooth writing and quick drying
- Choice of 4 colours ●●●●
- 0.53mm line width
- Comfortable soft grip
- Ergonomically designed triangular barrel for stress-free writing
- 700mtr writing length
- British design



Soft grip barrel for stress free writing



Ventilated pen cap with secure click



Ergonomically designed triangular barrel

Nickel silver tip 1.0mm
0.53mm line width



Quick dry LV ink

Smooth writing for left & right handed use



Product Code	Description	Packaging	Pen Type	Ink Colour	Trade Pack Quantity
50512	S-Tixx Ball Point Pen Blue	Box	Ball Point	●	12 pens
50513	S-Tixx Ball Point Pen Black	Box	Ball Point	●	12 pens
50514	S-Tixx Ball Point Pen Red	Box	Ball Point	●	12 pens
50515	S-Tixx Ball Point Pen Green	Box	Ball Point	●	12 pens
50516	S-Tixx Ball Point Pen Assorted	Box	Ball Point	●●●●	50 pens
50517	S-Tixx Ball Point Pen Blue	Box	Ball Point	●	50 pens
50518	S-Tixx Ball Point Pen Black	Box	Ball Point	●	50 pens

Tixx ✓

These entry level Tixx plastic Ball Point Pens are hybrid so combine gel ink and ball point for a smoother smudge free writing style. Its soft grip ensures comfortable writing.

- Disposable pen
- Hybrid gel ink - ultra smooth writing and quick drying
- 0.7mm line width
- Comfortable soft grip barrel
- Smooth writing action
- Strong metal retractable barrel with chrome finish
- 600 metres writing
- British design



Soft grip



Nickel silver tip

Product Code	Description	Packaging	Pen Type	Ink Colour	Trade Pack Quantity
50463	Tixx Ball Point Pen Blue	Box	Ball Point	●	12 pens
50464	Tixx Ball Point Pen Black	Box	Ball Point	●	12 pens
50465	Tixx Ball Point Pen Multi-coloured	Box	Ball Point	● ● ● ● ●	50 pens
50490	Tixx Ball Point Pen Pink	Box	Ball Point	●	12 pens
50491	Tixx Ball Point Pen Green	Box	Ball Point	●	12 pens
50492	Tixx Ball Point Pen Turquoise	Box	Ball Point	●	12 pens
50493	Tixx Ball Point Pen Orange	Box	Ball Point	●	12 pens
50494	Tixx Ball Point Pen Purple	Box	Ball Point	●	12 pens
50500	Tixx Ball Point Pen Blue	Blistercard	Ball Point	●	12 blisters
50501	Tixx Ball Point Pen Black	Blistercard	Ball Point	●	12 blisters
50502	Tixx Ball Point Pen Multi-coloured	Blistercard	Ball Point	● ● ●	12 blisters

Tixx ✓

These entry level easy to use Tixx disposable plastic pens are without the compromise of the lower quality products and are ready to use as they are not refillable, they have large write out lengths so there is no mess, ideal whilst on the move.

- Disposable pen
- Liquid gel ink
- 0.5mm line width
- Medium stainless steel nib
- Smooth writing action
- Lightweight, comfortable design
- 1500 metres writing
- British design

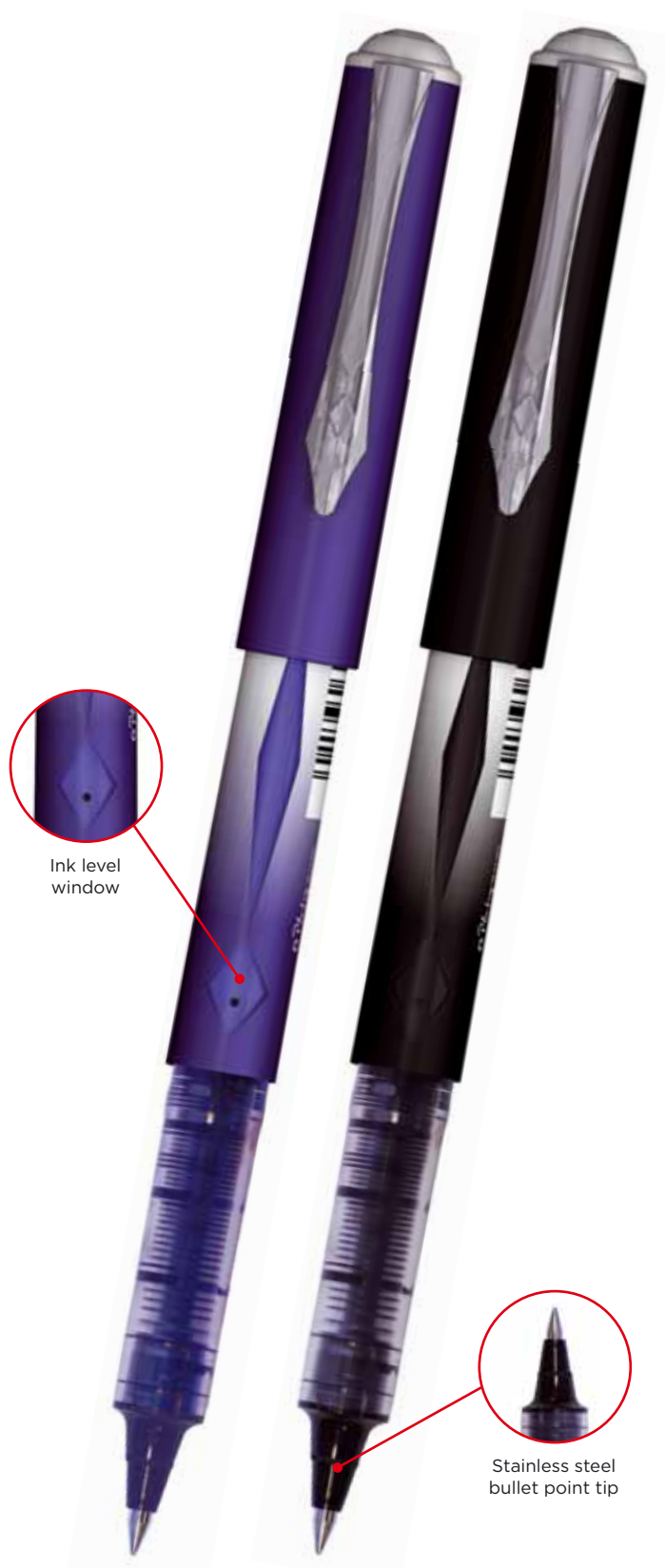

Ink level window

Stainless steel bullet point tip

Product Code	Description	Packaging	Pen Type	Ink Colour	Trade Pack Quantity
50457	Tixx Roller Ball Blue	Box	Roller Ball	●	12 pens
50458	Tixx Roller Ball Black	Box	Roller Ball	●	12 pens
50503	Tixx Roller Ball Blue	Blistercard	Roller Ball	●	12 blisters
50504	Tixx Roller Ball Black	Blistercard	Roller Ball	●	12 blisters

Tixx ✓

These entry level easy to use Tixx disposable plastic pens are without the compromise of the lower quality products and are ready to use as they are not refillable, they have large write out lengths so there is no mess, ideal whilst on the move.

- Disposable pen
- Liquid gel ink
- 0.5mm line width
- Narrow nib 'ideal for detailed graphics'
- Smooth writing action
- Lightweight, comfortable design
- 1200 metres writing
- British design



Product Code	Description	Packaging	Pen Type	Ink Colour	Trade Pack Quantity
50461	Tixx Roller Ball Needle Point Blue	Box	Roller Ball Needle Point	●	12 pens
50462	Tixx Roller Ball Needle Point Black	Box	Roller Ball Needle Point	●	12 pens
50509	Tixx Roller Ball Needle Point Blue	Blistercard	Roller Ball Needle Point	●	12 blisters
50510	Tixx Roller Ball Needle Point Black	Blistercard	Roller Ball Needle Point	●	12 blisters

Tixx ✓

These entry level easy to use Tixx disposable plastic pens are without the compromise of the lower quality products and are ready to use as they are not refillable, they have large write out lengths so there is no mess, ideal whilst on the move.

- No ink cartridge, no mess
- Disposable pen
- Quick-drying water-based ink - no smudges
- Medium stainless steel nib
- Lightweight, comfortable design
- 2000 metres writing
- British design

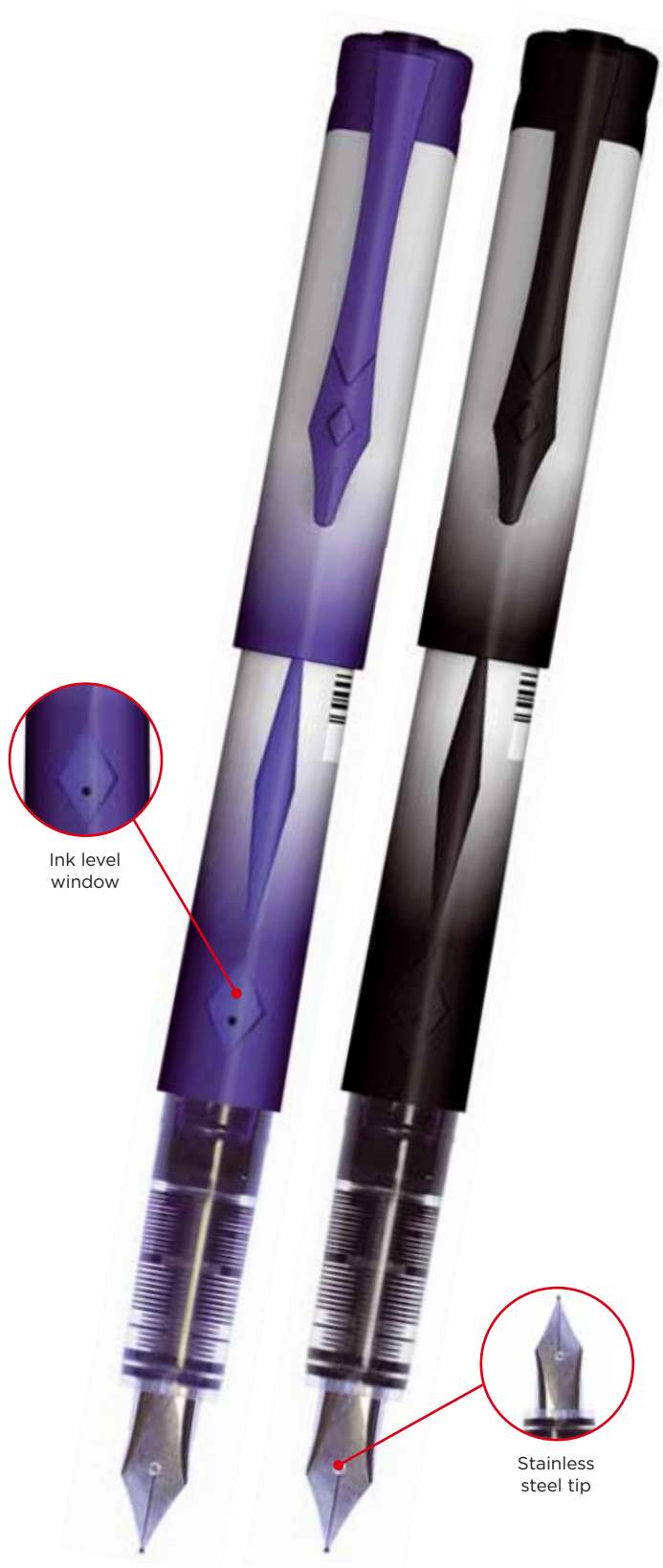

Ink level window

Stainless steel tip

Product Code	Description	Packaging	Pen Type	Ink Colour	Trade Pack Quantity
50459	Tixx Fountain Pen Blue	Box	Fountain Pen	●	12 pens
50460	Tixx Fountain Pen Black	Box	Fountain Pen	●	12 pens
50505	Tixx Fountain Pen Blue	Blistercard	Fountain Pen	●	12 blisters
50506	Tixx Fountain Pen Black	Blistercard	Fountain Pen	●	12 blisters

CARNABY STREET

Carnaby Street is an entry level, retractable Ball Point. This metal based pen is ideal for jotting down notes, writing essays, or making notes at important meetings.

- Retractable Ball Point
- Lightweight metal barrel
- Ergonomic soft grip for a comfortable writing experience
- Distinctive Platignum metal clip
- Platignum refills available
- Choice of 6 colours
- Gift box or blistercard with extra refill FREE
- British design



Soft grip



Ball Point

Product Code	Description	Packaging	Pen Type	Ink Colour*	Trade Pack Quantity
50424	Carnaby Street Ball Point Pen Yellow	Blistercard	Ball Point	● / ●	12 pens
50425	Carnaby Street Ball Point Pen Orange	Blistercard	Ball Point	● / ●	12 pens
50426	Carnaby Street Ball Point Pen Lilac	Blistercard	Ball Point	● / ●	12 pens
50427	Carnaby Street Ball Point Pen Pink	Blistercard	Ball Point	● / ●	12 pens
50428	Carnaby Street Ball Point Pen Blue	Blistercard	Ball Point	● / ●	12 pens
50429	Carnaby Street Ball Point Pen Green	Blistercard	Ball Point	● / ●	12 pens
50430	Carnaby Street Ball Point Pen Yellow	Gift Box	Ball Point	● / ●	12 pens
50431	Carnaby Street Ball Point Pen Orange	Gift Box	Ball Point	● / ●	12 pens
50432	Carnaby Street Ball Point Pen Lilac	Gift Box	Ball Point	● / ●	12 pens
50433	Carnaby Street Ball Point Pen Pink	Gift Box	Ball Point	● / ●	12 pens
50434	Carnaby Street Ball Point Pen Blue	Gift Box	Ball Point	● / ●	12 pens
50435	Carnaby Street Ball Point Pen Green	Gift Box	Ball Point	● / ●	12 pens
50448	Carnaby Street Ball Point Pen Assorted	Blistercard	Ball Point	● / ●	12 pens
50449	Carnaby Street Ball Point Pen Assorted	Gift Box	Ball Point	● / ●	12 pens

*Each pen comes with a blue & black refill

No.9

Our entry level range has been made for you on the move. Its lightweight metal body is designed to last and its soft rubber grip ensures a comfortable writing experience.

- Retractable Ball Point
- Lightweight metal barrel
- Ergonomic soft grip for a comfortable writing experience
- Distinctive Platignum metal clip
- Platignum refills available
- Choice of 4 colours/finishes
- Gift box or blistercard with extra refill FREE
- British design



Soft grip



Ball Point



Product Code	Description	Packaging	Pen Type	Ink Colour*	Trade Pack Quantity
50388	No.9 Ball Point Pen Black	Gift Box	Ball Point	● / ●	12 pens
50384	No.9 Ball Point Pen White	Gift Box	Ball Point	● / ●	12 pens
50232	No.9 Ball Point Pen Gun Metal Gold	Gift Box	Ball Point	● / ●	12 pens
50230	No.9 Ball Point Pen Stainless Steel	Gift Box	Ball Point	● / ●	12 pens

*Each pen comes with a blue & black refill

Vibe

Our sleek entry level fountain pen – designed for a first class writing experience. The slim designed body is engineered to last, is crafted from lightweight metal and finished with our elegant new matt colours. The design is combined with ultra smooth nib technology to bring the art of writing to life!

- Lightweight, slimline metal Fountain Pen
- Stainless Steel medium nib
- Ergonomic soft grip
- Removable cap protects nib and stops ink drying out
- Choice of Matt Black or White finish
- Includes gift box with extra refill FREE
- British design



Product Code	Description	Packaging	Pen Type	Ink Colour*	Trade Pack Quantity
50389	Vibe Fountain Pen Black	Gift Box	Fountain Pen	● / ●	12 pens
50385	Vibe Fountain White	Gift Box	Fountain Pen	● / ●	12 pens

*Each pen comes with a blue & black refill

Studio

Studio Ball Point Pen is for those who love design and want to make a bold statement! Crafted from aluminium, these are designed to combine a great writing experience with flair that encourages expression.

- Metal barrel Ball Point
- Shaped barrel profile for comfortable grip
- Twist action retractable ball point
- Distinctive Platignum metal clip
- Platignum refills available
- Choice of 8 fashion colours
- Includes gift box with extra refill FREE
- British design



Aluminium barrel and cap



Ball Point



Product Code	Description	Packaging	Pen Type	Ink Colour*	Trade Pack Quantity
50312	Studio Ball Point Pen Lime Green	Gift Box	Ball Point	● / ●	12 pens
50314	Studio Ball Point Pen Orange	Gift Box	Ball Point	● / ●	12 pens
50308	Studio Ball Point Pen Yellow	Gift Box	Ball Point	● / ●	12 pens
50316	Studio Ball Point Pen Pink	Gift Box	Ball Point	● / ●	12 pens
50310	Studio Ball Point Pen Turquoise	Gift Box	Ball Point	● / ●	12 pens
50296	Studio Ball Point Pen Red	Gift Box	Ball Point	● / ●	12 pens
50304	Studio Ball Point Pen Blue	Gift Box	Ball Point	● / ●	12 pens
50300	Studio Ball Point Pen White	Gift Box	Ball Point	● / ●	12 pens

*Each pen comes with a blue & black refill

Studio

Studio Fountain Pen is for those who love design and want to make a bold statement! Crafted from aluminium with a soft rubber grip, these are designed to combine a great writing experience with flair that encourages expression.

- Lightweight metal Fountain Pen
- Stainless Steel medium nib for durability
- Ergonomic soft grip for a comfortable writing experience
- Distinctive Platignum metal clip
- Choice of 8 colours/finishes
- Platignum ink cartridges available
- Gift box or blistercard with extra refill FREE
- British design



Aluminium barrel and cap



Stainless steel nib



Product Code	Description	Packaging	Pen Type	Ink Colour*	Trade Pack Quantity
50311	Studio Fountain Pen Lime Green	Gift Box	Fountain Pen	● / ●	12 pens
50313	Studio Fountain Pen Orange	Gift Box	Fountain Pen	● / ●	12 pens
50307	Studio Fountain Pen Yellow	Gift Box	Fountain Pen	● / ●	12 pens
50315	Studio Fountain Pen Pink	Gift Box	Fountain Pen	● / ●	12 pens
50309	Studio Fountain Pen Turquoise	Gift Box	Fountain Pen	● / ●	12 pens
50295	Studio Fountain Pen Red	Gift Box	Fountain Pen	● / ●	12 pens
50303	Studio Fountain Pen Blue	Gift Box	Fountain Pen	● / ●	12 pens
50299	Studio Fountain Pen White	Gift Box	Fountain Pen	● / ●	12 pens

*Each pen comes with a blue & black refill

Platignum Refills

At Platignum we have always adhered to the design principle of form and function.

A writing instrument should be a joy to behold but first and foremost it should make writing a pleasure.

To ensure the writing quality of your Platignum Pen is retained, we offer our high specification refill range.



Ball Point Refill

No.9 Ball Point Refill

Fountain Pen Cartridge

Product Code	Description	Packaging	Pen Type	Ink Colour	Trade Pack Quantity
50156	No.9 Ball Point Refill x 3	Blistercard	Ball Point	●	12 blisters
50157	No.9 Ball Point Refill x 3	Blistercard	Ball Point	●	12 blisters
50340	Ball Point Refill	Blistercard	Ball Point	●	12 blisters
50342	Ball Point Refill	Blistercard	Ball Point	●	12 blisters
50519	Fountain Pen Cartridge x 6	Box	Fountain Pen	●	1 pack
50520	Fountain Pen Cartridge x 6	Box	Fountain Pen	●	1 pack
50420	Fountain Pen Ink Converter x 12	Box	Fountain Pen	n/a	1 pack

Platignum POS

Platignum developed POS material to help promote and encourage sales of our complete range of pens. The various formats look great in any location.



Rotating Pen Stand

Branding Block Set



Tiered Circular
Foam Block

Product Code	Description	Trade Pack Quantity
50455	Rotating Pen Stand - holds 12 pens	Each
50456	Branding Block Set - holds 15 pens	Each
50489	Tiered Circular Foam Block - holds 24 pens	Each

Index by Product Code

Code	Description	Page
10035	Polyfile DL Electra Asstd	37
10057	Polyfile DL Clear	37
10070	Polyfile DL Classic Asstd	37
10088	Polyfile Foolscap Electra Asstd	37
10108	RingBinder 2 'O' Ring 15mm A5 Clear	50
10109	RingBinder 2 'O' Ring 15mm A5 Electra Blue	50
10119	RingBinder 2 'O' Ring 15mm A4 Clear	50
10120	RingBinder 2 'O' Ring 15mm A4 Electra Blue	50
10126	RingBinder 2 'O' Ring 15mm A4 Electra Asstd	50
10159	RingBinder 2 'O' Ring 25mm A4 Electra Blue	50
10165	RingBinder 2 'O' Ring 25mm A4 Electra Asstd	50
10180	RingBinder 2 'O' Ring 25mm A4 Blue	50
10181	RingBinder 2 'O' Ring 25mm A4 Red	50
10182	RingBinder 2 'O' Ring 25mm A4 Yellow	50
10183	RingBinder 2 'O' Ring 25mm A4 Clear	50
10278	HangGlider Index Tab Plastic Holders	31
10279	HangGliders Foolscap Black	31
10296	HangGliders A4 Black	31
10742	Polyfile A3 Classic Asstd	37
11160	Polyfile Foolscap Electra Green	37
11162	Polyfile Foolscap Electra Purple	37
11164	Polyfile Foolscap Electra Blue	37
11174	Polyfile A3 Clear	37
11185	Polyfile A3 Electra Asstd	37
11219	Expanding Organiser 13 Part A4 Black	60
11355	Polyfile A5 Electra Asstd	37
11360	Polyfile A5 Blue	37
11382	Polyfile A5 Clear	37
11395	Polyfile A5 Classic Asstd	37
11448	Zippa Bag A5 Asstd	22
11463	Zippa Bag A4+ Asstd	22
11702	Sticky Notes Neon Asstd 3x3"	16
11756	PolyPlus A4 Electra Asstd	42
11800	Polyfile CD A4 Electra Asstd	41
11893	Expanding Organiser 6 Part A4 Clear	60
11941	Presentation Display Book 20 Pocket A5 Clear	47
11951	Presentation Display Book 20 Pocket A4 Clear	47
11954	Presentation Display Book 20 Pocket A3 Clear	47
12127	Sticky Notes Yellow 1.5 x 2"	16
12128	Sticky Notes Yellow 3x3"	16

Code	Description	Page
12133	Sticky Notes Yellow 5x3"	16
12199	Display Book 10 Pocket A4 Electra Asstd	46
12219	Display Book 24 Pocket A4 Electra Asstd	46
12340	Indexed Display Book 40 Pocket A4 Black	47
12367	Polyfile Display Book 20 Pocket A4 Blue	45
12491	Polyfile ID A4 Black	40
12560	Polyfile ID A4 Clear	40
12565	Polyfile ID A4 Bright Asstd	40
12566	Polyfile RingBinder Wallet A4 Clear	54
12639	Filelastic A4 Asstd	34
12677	Clip File A4 Bright Asstd	32
12687	Zippa Bag 'S' A5 Blue	22
12692	Zippa Bag 'S' A5 Red	22
12722	Zippa-Bag 'S' A5 Asstd	22
12736	Zippa Bag 'S' A4 Blue	22
12772	ClampBinder A4 Clear	32
12790	ClampBinder A4 Electra Asstd	32
12796	Zippa Bag 'S' A4 Asstd	22
12804	Zippa Bag 'S' A4+ Blue	22
12805	Zippa Bag 'S' A4+ Red	22
12806	Zippa Bag 'S' A4+ Yellow	22
12814	Zippa Bag 'S' A4+ Asstd	22
12821	Zippa Bag 'S' A4++ Asstd	22
12823	Zippa Bag 'S' A3+ Asstd	22
12844	Polyfile A4 Electra Asstd	37
12845	DocBox 25 A4 Blue	28
12849	DocBox 25 A4 Clear	28
12858	DocBox 35 A4 Blue	28
12861	DocBox 35 A4 Clear	28
12867	DocBox 60 A4 Blue	28
12871	DocBox 60 A4 Clear	28
12940	Penpal Electra Asstd	29
13078	PinPoint ST Correction Pen 7ml CDU	11
13139	Hi-Tech Correction Fluid 20ml	11
13150	Index Tab PageMarker White/Asstd Blister	13
13154	Index Tab Highlighter Neon Asstd Blister	13
13223	Sticky Notes Mini Neon Asstd 2x2"	16
13263	Polyfile P A4 Clear	41
13266	Polyfile P A4 Electra Asstd	41
13274	Polyfile P A5 Electra Asstd	41

Code	Description	Page
13280	Polyfile P A5 Clear	41
13287	Polyfile P A6 Electra Asstd	41
13293	Polyfile P A6 Clear	41
13300	Polyfile P A7 Electra Asstd	41
13306	Polyfile P A7 Clear	41
13368	Presentation RingBinder 4 'O' Ring 25mm A4 Clear	51
13371	Executive RingBinder 2 'O' Ring 25mm A4 Clear	51
13372	Executive RingBinder 2 'O' Ring 25mm A4 Electra Blue	51
13377	Executive RingBinder 2 'O' Ring 25mm A4 Electra Asstd	51
13386	Executive Presentation RingBinder 4 'D' Ring 25mm A4 Clear	51
13387	Executive Presentation RingBinder 4 'D' Ring 25mm A4 Electra Blue	51
13392	Executive Presentation RingBinder 4 'D' Ring 25mm A4 Electra Asstd	51
13434	U Name it mini Correction Roller Blister	11
13520	The Art of Presentation 6 Part Expanding Organiser Blue/Black	63
13521	The Art of Presentation 13 Part Expanding Organiser Blue/Black	63
13524	The Art of Presentation Filecase 24 Part Blue/Black	63
13527	Sticky Notes Neon Asstd 3x3"	16
13528	Sticky Notes Neon Asstd 5x3"	16
13608	Zeon Expanding Organiser 6 Part A4 Asstd	62
13701	Zeon Organiser 13 Part Foolscape Asstd	62
13720	Filelastic A4 Electra Asstd	34
13727	TabFile RingBinder Wallet A4 Clear	56
13729	BoxOffice Business Card Clear	28
13732	BoxOffice A5 Clear	28
13733	BoxOffice A4 Clear	28
13735	BoxOffice A2 Clear	28
13781	BoxOffice Business Card Electra Asstd	28
13801	BoxOffice A5 Electra Asstd	28
13806	BoxOffice A4 Electra Asstd	28
13812	BoxOffice A3 Electra Asstd	28
13817	BoxOffice A2 Electra Asstd	28
13821	Expanding Organiser 6 Part A4 Electra Asstd	60
13853	PolyWally A4 Electra Asstd	42
13900	Clipboard with Pen A4 Asstd	29
13906	Index Tab Arrow Highlighter Asstd Blister	13
13912	TwinTip Glue 28ml CDU	19
14007	DisplayBox of 30 Sticky Notes 76x50mm	15
14029	The Art of Presentation MeetingMate 4 'O' Ring 25mm Blue/Black	63
14030	TwinFile A4 Clear	33
14031	TwinFile A4 Electra Asstd	33
14032	TwinFile A4 Electra Blue	33
14103	Display Book 24 pocket A3 Electra Asstd	46
14129	Zippa Bag 'S' DL Electra Asstd	22
14135	Zippa Bag 'S' A5 Electra Asstd	22

Code	Description	Page
14141	Zippa Bag 'S' A4 Electra Asstd	22
14321	NoteGuard A4 Electra Asstd	45
14322	NoteGuard A5 Electra Asstd	45
14323	NoteGuard A6 Electra Asstd	45
14324	NoteGuard Pocket Size Electra Asstd	45
14617	RingBinder Easel Landscape A4 Clear	51
14734	Polyfile ID A4 Electra Asstd	40
14832	DocBox 25 A4 Electra Asstd	28
14855	RingBinder CardStore A4 Clear	56
14890	RingBinder Display Book 20 Pocket A4 Clear	47/54
14920	Presentation TwinFile A4 Clear	33
14947	The Art of Presentation 4 Part ZipGrip Organiser Foolscape Blue/Black	63
14965	Filelastic 8-Part A4 Electra Asstd	34
14966	Polyfile Trio Foolscape Clear	42
14967	Polyfile Trio Foolscape Electra Asstd	42
14997	SwingFile A4 Electra Asstd	33
15055	SlipFile A4 Clear	33
15078	Eligo Executive CardFile A4 Black	56
15158	Airbag 8x8" Blue/Yellow Asstd	26
15171	Eligo Portrait 13 Part Desk Expander A4 Black	61
15173	Multicoloured 13 Part Organiser A4 Clear	60
15174	Eligo Landscape 13 Part Desk Expander A4 Black	61
15299	High Capacity Zippa Bag A4+ Asstd	26
15303	The Art of Presentation MeetingMate 2 'O' Ring 25mm Black	63
15309	The Art of Presentation 4 Part ZipGrip Organiser Foolscape Black	63
15411	Lite Polyfile A4 Asstd	39
15412	Lite Polyfile A4 Clear	39
15413	Lite Display Book 20 Pocket A4 Asstd	46
15415	Lite Display Book 40 Pocket A4 Asstd	46
15428	Bio2 Polyfile A4 Clear	39
15431	Bio2 Ringbinder 2 'O' Ring 25mm A4 Clear	50
15439	Bio2 Punched 25 Pockets A4 Clear	55
15440	Bio2 Punched 100 Pockets A4 Clear	55
15637	Fusion Flexible Display Book A3/A4 Asstd	46
15643	Fusion Polyfile A4 Asstd	40
15650	Fusion Stepped Index 13 Part Desk Expander Asstd	62
15688	Polyfile USB A4 Electra Asstd	39
15689	Polyfile USB Foolscape Electra Asstd	39
15690	Polyfile Twin Pocket Foolscape Clear	38
15691	Polyfile Twin Pocket A4 Electra Asstd	38
15693	Polyfile Duo A4/A5 Electra Asstd	38
15694	Polyfile RingBinder Wallet HC Landscape A4 Electra Asstd	55
15695	Polyfile RingBinder Wallet HC Portrait A4 Electra Asstd	55
15697	Eligo Doc Case and Expander Black	61

Code	Description	Page
15699	Fusion Travel Wallet DL Asstd	60
15700	Fusion VariFile A4 Asstd	34
15716	TripleView A4 RingBinder 2 'O' Ring & Wallet 15mm Clear	52
15717	TripleView A4 RingBinder 2 'O' Ring & 2 Wallets 25mm Electra Asstd	52
15718	TripleView A4 RingBinder 2 'O' Ring & Wallet 25mm Electra Asstd	52
15719	TripleView A4 RingBinder 2 'O' Ring & Wallet 25mm Clear	52
15724	Super Sticky Glue 21g CDU	18
15738	Polka Dot RingBinder 2 'O' Ring 25mm A4 Clear	50
15742	Polka Dot Polyfile Foolscap	41
15748	Correction Roller Slider Blister	11
15749	Polyfile RingBinder Wallet HC Portrait A4 Clear	55
15754	Super Sticky Glue 36g CDU	18
15759	Rainbow Pink NeonMix Sticky Notes 3x3"	16
15760	Rainbow Green NeonMix Sticky Notes 3x3"	16
15761	Rainbow Multicoloured NeonMix Sticky Notes 3x3"	16
15763	Sorta File A5 Electra Asstd	26
15764	Sorta File A4 Electra Asstd	26
15765	PenPal Polka Dot	29
15767	Rainbow 6 Part Expanding Organiser A4 Clear	58
15768	Rainbow 13 Part Expanding Organiser A5 Clear	58
15769	Rainbow 3 Part Expanding Organiser DL Clear	58
15770	Rainbow 6 Part Expanding Organiser DL Clear	58
15775	Polyfile Portrait Pack 4 Piece Electra Asstd	37
15776	Polyfile Landscape Pack 3 Piece Electra Asstd	37
15779	Zipit Presentation ReOrganiser Display Book 20 Pocket A4 Black	45
15780	Zipit Presentation ReOrganiser Display Book 40 Pocket A4 Black	45
15781	Zipit Presentation ReOrganiser Display Book 60 Pocket A4 Black	45
15782	Presentation Display Book 20 Pocket A4 Black	47
15783	Presentation Display Book 40 Pocket A4 Black	47
15784	Presentation Display Book 60 Pocket A4 Black	47
15785	Polyfile RingBinder Wallet A4 Electra Asstd	54
15786	Polyfile RingBinder Wallet A5 Clear	54
15787	Rainbow Polyfile ID A4 Bright Asstd	40
15788	Metallic Clipboard A4	29
15789	Removable Sticky Labels FSC Pastel Asstd 1x3.5"	16
15790	Removable Sticky Labels FSC Neon Asstd 1x3.5"	16
15791	Removable Sticky Labels FSC Pastel Asstd 2x3.5"	16
15792	Removable Sticky Labels FSC Neon Asstd 2x3.5"	16
15797	PVP Glue 9g CDU	18
15798	PVP Glue 15g CDU	18
15799	PVP Glue 21g CDU	18
15800	PVP Glue 36g CDU	18
15802	Rainbow A4 Suspension Expander	32
15803	Rainbow Foolscap Suspension Expander	32

Code	Description	Page
15804	Rainbow 8-part FileLastic A4	34
15808	Rainbow Display Book 24 Pocket A4 Asstd	46
15809	Rainbow 13 Part Desk Expander A4 Clear	58
15813	EPPE Zippa-Bag A5 White	26
15814	EPPE Zippa-Bag A5 Asstd	26
15815	EPPE Zippa-Bag Foolscap White	26
15816	EPPE Zippa-Bag Foolscap Asstd	26
15817	EVA Mesh Zippa-Bag DL Asstd	23
15818	EVA Mesh Zippa-Bag A5 Asstd	23
15819	EVA Mesh Zippa-Bag Foolscap Asstd	23
15820	MegaStick Glue 21g CDU	19
15821	MegaStick Glue 36g CDU	19
15824	Super Blue Glue 21g CDU	20
15825	Super Blue Glue 36g CDU	20
15829	PVP Glue 100g CDU	18
15832	Craft Polyfile 13x13" Clear	42
15835	PinPoint ST Correction Pen 7ml Blister	11
15836	Hi-Tech Correction Fluid 20ml Blister	11
15837	EVA Mesh Zippa-Bag DL Black	23
15838	EVA Mesh Zippa-Bag A5 Black	23
15839	EVA Mesh Zippa-Bag Foolscap Black	23
15840	Lined Pad Pastel Yellow	15
15841	Lined Pad Neon Yellow	15
15842	Lined Pad Neon Green	15
15843	Lined Pad Neon Magenta	15
15844	Index Tab PageMarker Asstd Blister	15
15845	Index Tab PageMarker Asstd Blister	15
15846	Index Tab Highlighter Neon Asstd Blister	13
15847	Rainbow Blue NeonMix Sticky Notes 3x3"	16
15848	Desk Memo Set	15
15849	Rainbow & Black 6 Part Expanding Organiser DL Black	59
15850	Rainbow & Black 13 Part Stepped Expanding Organiser A4 Black	59
15851	Rainbow & Black 13 Part Desk Expander A4 Black	59
15852	Rainbow & Black 24 Part Desk Expander A4 Black	59
15856	EVA Mesh Zippa-Bag A6 Black	23
15857	HangGliders A4 Clear	31
15858	HangGliders Fscap Clear	31
15859	Eligo Landscape 13pt Desk Expander Fscap Black	61
15860	Eligo Landscape 26pt Desk Expander A4 Black	61
15861	Eligo ReOrganiser Project Book A5	44
15862	Eligo ReOrganiser Project Book A4	44
15863	Eligo ReOrganiser Display Book A4	44
15864	Eligo ReOrganiser Refill Paper A5	44
15865	Eligo ReOrganiser Refill Paper A4	44

Code	Description	Page
15866	Eligo ReOrganiser Refill Pockets A4	44
15869	ZipIt Reorganiser Refill pockets (20pk)	45
15870	EVA Mesh HC Project Zippa Bag A4++ - Black	25
15871	EVA Mesh HC Project Zippa Bag A4++ - Blue	25
15872	EVA Mesh HC Project Zippa Bag A4++ - Red	25
15873	EVA Mesh HC Project Zippa Bag A4++ - Yellow	25
15874	EVA Mesh HC Project Zippa Bag A3 - Black	25
15875	EVA Mesh HC Project Zippa Bag A3 - Blue	25
15876	EVA Mesh HC Project Zippa Bag A3 - Red	25
15877	EVA Mesh HC Project Zippa Bag A3 - Yellow	25
15878	EVA Mesh HC A6 Zippa Bag - Black	24
15879	EVA Mesh HC DL Zippa Bag - Black	24
15880	EVA Mesh HC A5 Zippa Bag - Black	24
15881	EVA Mesh HC Foolsap Zippa Bag - Black	24
15882	Filing Index Tabs 38x25mm - 80 Tabs Assorted	14
15883	Filing Index Tabs 38x51mm - 24 Tabs Assorted	14
15884	Filing Index Tabs 38x76mm - 24 Tabs Assorted	14
15885	Filing Index Tabs with Ruler 37x50mm - 30 Tabs Assorted	14
15886	Clipboard - A4 - Blue	30
15887	Clipboard - A4 - Turquoise	30
15888	Eligo Display Book 10 Pocket A4 Black Asstd	44
15889	Double-Sided White Board with pen & eraser - Blue	30
15890	Double-Sided White Board with pen & eraser - Green	30
15891	Double-Sided White Board with pen & eraser - Red	30
15892	Double-Sided White Board with pen & eraser - Yellow	30
40003	Scribbler Battery Powered Sharpener	95
40015	Shredder Lubricant Sachets	77
40023	Trio Replacement Blade	98
40024	Plastic Wedge Sharpener Bag	91
40032	Single Hole Canister Sharpener CDU	91
40033	Double Hole Canister Sharpener CDU	91
40050	Sketch Electrical Sharpener	97
40051	Contour Electrical Sharpener	97
40052	Latitude Electrical Sharpener	98
40069	Shredder Oil Lubricant 240ml Bottle	77
40100	Ikon Mechanical Sharpener	94
40103	Curve Mechanical Sharpener	94
40104	Scholar Mechanical Sharpener	94
40158	800XC-P5 Micro-Cut Sheet Shredder	75
40179	Soft Grip Sharpener Tub	92
40186	SuperSlim A4 Laminator Red	79
40187	SuperSlim A4 Laminator Blue	79
40188	230LR Compact A4 Laminator Silver	79
40191	330LR Compact A3 Laminator Silver	79

Code	Description	Page
40210	Metal Wedge Single Sharpener Box	91
40212	Metal Wedge Double Sharpener Box	91
40228	The Triple Canister Sharpener CDU	93
40230	800XC Cross-Cut Shredder	68
40232	VariPoint Electrical Sharpener	96
40233	Multipoint Electrical Sharpener	97
40234	Multipoint Replacement Blade	97
40235	Pointi Mechanical Sharpener	94
40236	VariPoint Replacement Blade	96
40237	1200XXCD Micro-Cut Shredder	75
40240	Shredder Oil Lubricant 350ml Bottle	77
40244	1600XCD Cross-Cut Shredder	72
40245	MiniPro Battery/USB Dual Powered Sharpener	95
40247	VariPlug Dual USB Universal Travel Adapter Red	105
40248	VariPlug Dual USB Universal Travel Adapter Blue	105
40249	VariPlug Dual USB Universal Travel Adapter Black	105
40253	VariPlug Dual USB Universal Travel Adapter Orange	105
40254	VariPlug Dual USB Universal Travel Adapter Yellow	105
40255	VariPlug Dual USB Universal Travel Adapter Green	105
40259	Plastic Wedge Sharpener Box	91
40260	SlimLine A3 Trimmer Silver/Red	101
40261	SlimLine A3 Trimmer Silver/Blue	101
40262	SlimLine A4 Trimmer Silver/Red	101
40263	SlimLine A4 Trimmer Silver/Blue	101
40264	SlimLine Trimmer Cutting Head Red	101
40265	SlimLine Trimmer Cutting Head Blue	101
40271	Twin Inverta Sharpener CDU	93
40273	Large Plastic Eraser CDU	87
40277	Large Soft Eraser CDU	87
40283	Shielded Eraser Purple Blister	87
40284	Large Eraser & Single Zinc Sharpener Blister	90
40285	Blinc Blinc Sharpener CDU	91
40286	Blinc Blinc Sharpener Blister	91
40287	Soft Grip Sharpener Blister	92
40288	Twin Soft Grip Sharpener Tub	92
40289	Twin Soft Grip Sharpener Blister	92
40290	Canister Flip Sharpener CDU	92
40291	Canister Flip Sharpener Blister	92
40294	Combo Sharpener & Eraser Turquoise Blister	90
40295	Twin Combo Sharpener & Eraser CDU	90
40296	Twin Combo Sharpener & Eraser Blister	90
40300	X-Securia 800XC Cross-Cut Shredder	69
40304	VariPoint Mini Battery/USB Dual Powered Sharpener	95
40305	OmniPoint Mechanical Sharpener	95

Code	Description	Page
40306	OmniPoint Mechanical Sharpener Replacement Blade	95
40309	Fusion 2 Dual Power Sharpener	96
40310	VertiPoint Electric Sharpener	96
40311	VertiPoint Replacement Blade	96
40312	Shielded Erasers Tub	87
40313	VariSocket4 Surge Protected Power Board	106
40314	Pencil Top Eraser Blister	87
40315	TimeSaver2 A3 Laminator Silver	80
40317	VariSocket6 Surge Protected Power Board	106
40319	Beehive Pencil Sharpener Tub	93
40320	Click Click Sharpener CDU	93
40323	Large Soft Eraser Tub	87
40327	AutoFeed Electrical Sharpener	98
40328	AutoFeed Service Kit	98
40329	1400XCD 14 Sheet Cross-Cut Shredder	71
40330	VariPlug Dual USB Universal Travel Adaptor Pink	105
40331	Click Click Sharpener Blister	93
40332	Click Click Sharpener Tub	93
40334	Eraser Armadillo Tub	88
40336	Stripey Eraser Tub	88
40341	Spaceship Sharpener & Eraser CDU	90
40342	3 in 1 Creative Trimmer	100
40343	5 in 1 Creative Trimmer	100
40344	5 in1 Creative Trimmer - Replacement Cutting Head	100
40345	5 in1 Creative Trimmer - Replacement Corner Trimmer	100
40346	5 in1 Creative Trimmer - Replacement Mat Strip	100
40347	1000XC Plus Cross Cut Shredder	70
40348	800XC-P4 Micro Cut Sheet Shredder	74
40350	Armoured 1000 Professional A2 Laminator Silver	82
40351	Armoured 660 Heavy Duty A2 Laminator Silver	81
40352	Armoured 660 Heavy Duty A3 Laminator Silver	81
40353	Armoured Pouch Carrier A4 Pack of 1	83
40354	Armoured Pouch Carrier A3 Pack of 5	83
40355	Armoured Pouch Carrier A4 Pack of 1	83
40356	Armoured Pouch Carrier A3 Pack of 5	83
40357	600XC-P4 Cross Cut Shredder	68
40358	SlimLine A3 Trimmer Silver/Purple	101
40359	SlimLine A4 Trimmer Silver/Purple	101
40360	SlimLine Trimmer Cutting Head Purple	101
40361	800XC-P4 Cross-Cut Shredder	68
40362	600XC Super Micro-Cut Shredder	74
40363	2000XCD Plus Cross-Cut Shredder	73
40364	1000XC-P4 EL Cross-Cut Shredder	69
40365	Combo Sharpener & Eraser Pink Blister	90

Code	Description	Page
40366	2400XCD Cross-Cut Shredder	73
40367	Shielded Eraser Pink Blister	87
40368	Superfast Laminator	80
40369	Optik Eraser CDU	88
40370	LineOut Ruler Eraser CDU	89
40371	LineOut Mini Ruler Eraser CDU	89
40372	Wedge Eraser Pink/Purple Blister	89
40373	Wedge Eraser Blue/Green Blister	89
40374	Wavez Eraser CDU	89
40375	Marble Eraser CDU	88
40377	Marble Eraser Blister	88
40378	Double Hole Click Sharpener Blister	92
40802	Latitude Replacement Blade	98
40805	Sketch Replacement Blade	97
40806	Contour Replacement Blade	97
40807	Curve Replacement Blade	94
40906	Trio Electrical Sharpener	98
40907	Scholar Replacement Blade	94
40908	Ikon and Ebony Replacement Blade	94
43110	ProScalpel Blister	103
43801	ProScalpel Blades No.11	103
43802	ProScalpel Blades No.10A	103
45009	1000XC Cross-Cut Shredder	70
45010	1000XCD Cross-Cut Shredder	71
45011	1500XCD Cross-Cut Shredder	72
48017	Laminating Pouches A4 2x75micron Pack 100	82
48021	Laminating Pouches A4 2x125micron Pack 100	82
50156	No.9 Ball Point Pen Blue Refill Blister	135
50157	No.9 Ball Point Pen Black Refill Blister	135
50230	No.9 Stainless Steel Ball Point Pen Gift Box	131
50232	No.9 Gun Metal Gold Ball Point Pen Gift Box	131
50295	Studio Red Fountain Pen Gift Box	134
50296	Studio Red Ball Point Pen Gift Box	133
50299	Studio White Fountain Pen Gift Box	134
50300	Studio White Ball Point Pen Gift Box	133
50303	Studio Blue Fountain Pen Gift Box	134
50304	Studio Blue Ball Point Pen Gift Box	133
50307	Studio Yellow Fountain Pen Gift Box	134
50308	Studio Yellow Ball Point Pen Gift Box	133
50309	Studio Turquoise Fountain Pen Gift Box	134
50310	Studio Turquoise Ball Point Pen Gift Box	133
50311	Studio Lime Green Fountain Pen Gift Box	134
50312	Studio Lime Green Ball Point Pen Gift Box	133
50313	Studio Orange Fountain Pen Gift Box	134

Code	Description	Page
50314	Studio Orange Ball Point Pen Gift Box	133
50315	Studio Pink Fountain Pen Gift Box	134
50316	Studio Pink Ball Point Pen Gift Box	133
50340	Ball Point Pen Blue Refill Blister	135
50342	Ball Point Pen Black Refill Blister	135
50384	No.9 White Ball Point Pen Gift Box	131
50385	Vibe White Fountain Pen Gift Box	132
50388	No.9 Black Ball Point Pen Gift Box	131
50389	Vibe Black Fountain Pen Gift Box	132
50420	Ink Converter Box	135
50424	Carnaby Street Ball Point Pen Yellow Blister	130
50425	Carnaby Street Ball Point Pen Orange Blister	130
50426	Carnaby Street Ball Point Pen Lilac Blister	130
50427	Carnaby Street Ball Point Pen Pink Blister	130
50428	Carnaby Street Ball Point Pen Blue Blister	130
50429	Carnaby Street Ball Point Pen Green Blister	130
50430	Carnaby Street Ball Point Pen Yellow Gift Box	130
50431	Carnaby Street Ball Point Pen Orange Gift Box	130
50432	Carnaby Street Ball Point Pen Lilac Gift Box	130
50433	Carnaby Street Ball Point Pen Pink Gift Box	130
50434	Carnaby Street Ball Point Pen Blue Gift Box	130
50435	Carnaby Street Ball Point Pen Green Gift Box	130
50448	Carnaby Street Ball Point Pen Asstd Blister	130
50449	Carnaby Street Ball Point Pen Asstd Gift Box	130
50455	Rotating Pen Stand	136
50456	Branding Block Set	136
50457	Tixx Roller Ball Blue Box	127
50458	Tixx Roller Ball Black Box	127
50459	Tixx Fountain Pen Blue Box	129
50460	Tixx Fountain Pen Black Box	129
50461	Tixx Roller Ball Needle Point Blue Box	128
50462	Tixx Roller Ball Needle Point Black Box	128
50463	Tixx Ball Point Pen Blue Box	126
50464	Tixx Ball Point Pen Black Box	126
50465	Tixx Ball Point Pen Multi-coloured Box	126
50489	Tiered Circular Foam Block	136
50490	Tixx Ball Point Pen Pink Box	126
50491	Tixx Ball Point Pen Green Box	126
50492	Tixx Ball Point Pen Turquoise Box	126
50493	Tixx Ball Point Pen Orange Box	126
50494	Tixx Ball Point Pen Purple Box	126
50500	Tixx Ball Point Pen Blue Blister	126
50501	Tixx Ball Point Pen Black Blister	126
50502	Tixx Ball Point Pen Multi-coloured Blister	126

Code	Description	Page
50503	Tixx Roller Ball Blue Blister	127
50504	Tixx Roller Ball Black Blister	127
50505	Tixx Fountain Pen Blue Box Blister	129
50506	Tixx Fountain Pen Black Box Blister	129
50509	Tixx Roller Ball Needle Point Blue Blister	128
50510	Tixx Roller Ball Needle Point Black Blister	128
50512	S-Tixx Ball Point Pen Blue Box	125
50513	S-Tixx Ball Point Pen Black Box	125
50514	S-Tixx Ball Point Pen Red Box	125
50515	S-Tixx Ball Point Pen Green Box	125
50516	S-Tixx Ball Point Pen Assorted Box	125
50517	S-Tixx Ball Point Pen Blue Box	125
50518	S-Tixx Ball Point Pen Black Box	125
50519	Ink Cartridges x 6 Blue CDU	135
50520	Ink Cartridges x 6 Black CDU	135
10087X	Polyfile Foolscap Classic Asstd	37
11151X	Polyfile Foolscap Blue	37
11152X	Polyfile Foolscap Red	37
11154X	Polyfile Foolscap Clear	37
12838X	Polyfile A4 Blue	37
12839X	Polyfile A4 Red	37
12840X	Polyfile A4 Yellow	37
12841X	Polyfile A4 Clear	37
12843X	Polyfile A4 Classic Asstd	37
40058X	Elite 480 A3 Trimmer	102
40059X	Elite Series Trimmer Replacement Cutting Head	102
40087X	Elite 670 A2 Trimmer	102
40228S	The Triple Canister Sharpener Blister	93
40909X	Edge Series Trimmer Replacement Cutting Head	102
42013X	Edge 320 A4 Trimmer	102
42014X	Edge 450 A3 Trimmer	102

Product Registration

Please register your Swordfish product at www.snopakebrands.com to validate your warranty and ensure you receive the best level of customer care.

By registering your product, you will have the option to receive special offers and promotions.

Troubleshooting & Product Support

For troubleshooting and product support, please visit www.snopakebrands.com.

The website offers guidance on how to use your Swordfish product as well as technical support and other useful online resources.

- FAQs
- Step by Step Guides
- Troubleshooting
- User Guides
- Product Registration
- Full Terms & Conditions



www.snopakebrands.com

Help and advice is just one click away



Snopake[®] | brands

SNOPAKE LTD • LONDON • ENGLAND

28 Perivale Park, Horsenden Lane South,
Perivale, UB6 7RJ, England.

Main Tel: +44 (0)20 8991 1666
Fax: +44 (0)20 8998 2000

Sales: +44 (0)20 8991 9901
Email: uksales@snopake.com

www.snopakebrands.com

Product Code: 15725

