

Swordfish **Armoured660**

Heavy Duty A3 & A2 Laminators
For Professional Use



Scan here to
download or view
these instructions
in other languages



Scan here to
watch a helpful
hints video



Please read this manual completely before using your laminator as incorrect use can cause serious damage.

Safety Precautions

Failure to comply with any of the following safety precautions could result in serious injury, fire or electric shock.



This equipment is not intended for use by children. It is not a toy.



Unauthorised attempts at repair will invalidate the warranty.



Do not allow water, or damp media, to enter the laminator.



Do not cover the laminator, or place anything on it. Risk of fire!



Disconnect after use or when cleaning the laminator.



The laminator is hot and contains hazardous moving parts.



Do not operate the laminator on, or near, combustible objects.



Do not allow clothing or jewellery to enter the laminator. Risk of fire or electric shock!



Do not leave the laminator unattended during operation.



Do not use aerosol products on or near this machine (or any other electrical appliance) as the contents may be flammable.

SPECIFICATIONS

Suitability		Cold Lamination Option	✓
		Auto Shut-Off	X
	Small Office & Office	Number of Rollers	4
What makes it special?	High speed, heavy duty	Warm-up Time	4 - 6 minutes
Swordfish UK Product Code	A3 - 40352 A2 - 40351	Speed (time to laminate an A4 sheet)	32 seconds
Maximum Paper Size	A3 / A2	Working Speed	660mm/minute
Colour	Black/Dark Silver	Working Temperature	88° - 170°C
Feed Entry Width (mm)	A3 - 320mm A2 - 450mm	Product Dimensions H x W x D (mm)	A3 - 110 x 520 x 220 A2 - 113 x 631 x 215
Maximum Pouch Thickness	2 x 250 [500] Microns	Weight (kg)	A3 - 8kg / A2 - 12kg
Maximum Pouch Thickness Total (mm)	1.0mm	Power	A3 - 220/230V 50Hz, 600W, 2.8A A2 - 220/230V 50Hz, 785W, 3.6A
Jam Release	✓		
Reverse Control	✓	Product Warranty (years)	2 years

Product Warranty Swordfish Laminator

SWORDFISH 2-YEARS LIMITED WARRANTY FOR PARTS AND LABOUR

Swordfish laminators are warranted against failure or malfunction due to faulty components or workmanship for a period of two years from the date of purchase by the original consumer. Defects or failures, which have been caused by incorrect or wrongful use, regardless whether unintentional or intentional during the operation or maintenance of the device, are excluded from the warranty. There are no user-serviceable parts inside a Swordfish laminator. Unauthorized repair or attempts to service the unit will invalidate the warranty.

For service of the unit under warranty, please return your Swordfish laminator with proof of purchase to your dealer or contact Swordfish customer service. In the event of returning the machine under warranty, suitable packaging must be used. Insufficient packaging resulting in damage will invalidate the warranty.

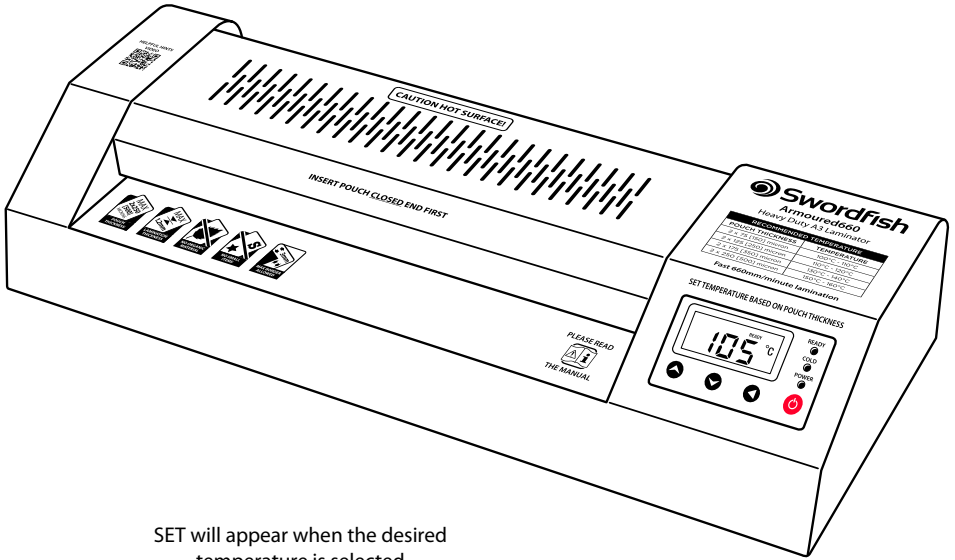

SET will appear when the desired temperature is selected

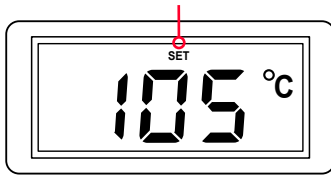

READY will flash whilst warming or cooling

The READY light illuminates when the set temperature is reached

The COLD light illuminates when ready for cold lamination

The POWER light indicates that the machine is operational

Hot/Cold/Off Button

TEMP: Increase Temperature

REV: Decrease Temperature

PRESS & HOLD: Reverse Button

Please read this manual completely before using your laminator as incorrect use can cause serious damage. Failure to follow the instructions in this manual could invalidate your warranty!

Quick Start Guide

- 1** Position the laminator on a suitable flat surface, within easy reach of a 13Amp socket, ensuring that there is sufficient space behind the machine for the laminations to lay flat.
- 2** Connect the laminator to the 13Amp socket and press the isolating switch on the back of the machine to the "on" position. The "power" light will illuminate.
- 3** Press the red "Hot/Cold/Off" button on the control panel once and the machine will run and start warming up. Press the red "Hot/Cold/Off" button again and the machine will go into cold lamination mode. Press the button a third time and the machine will stop working.
- 4** Set the desired temperature according to the guide printed on the laminator. Note that setting the temperature too high can cause your pouch to jam!
- 5** The "ready" light will illuminate after 3-4 minutes, depending on the required temperature. Laminating can now begin.
- 6**  You must use the supplied pouch carrier if you intend to laminate any of the following:
 - Multiple items within a single pouch
 - Irregular shaped items
 - Soft material such as newspaper, tissue, paper and fabrics
 - Any item that leaves a border of more than a 3mm around its edges

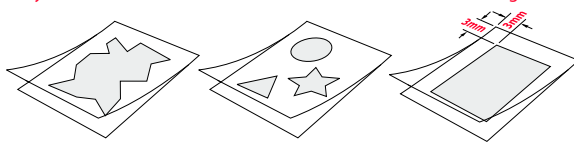

Replacement pouch carriers are available from www.snopakebrands.com or your usual pouch supplier.

- 7** If the lamination is imperfect, adjust the temperature to correct the fault – see page 9.
- 8** Before turning off the machine, press the red "Hot/Cold/Off" button twice. The "cold" light will illuminate. Allow the laminator to run for 5 minutes before turning off the power. This will allow the rollers to cool evenly.

To get the best results from your laminator and extend its working life, please turn to page 6.

Getting Started

The Swordfish Armoured660 laminators are steel-cased, heavy-duty, variable temperature machines. They are equipped with sophisticated temperature control, large 25.6mm precision rollers and a steel cooling plate – all of which combine to give perfect laminations.

1 Position the laminator on a level surface, close to a 13Amp socket.



CAUTION

Do not locate the laminator:

- Near any heat appliances such as heater or stove
- Directly exposed to sunlight
- Close to an air-conditioning unit
- In a poor ventilated environment
- On an irregular or inclined surface

2 Allow enough space behind the laminator for your laminations to lay flat whilst cooling. Do not cover the machine or place anything on top of it.

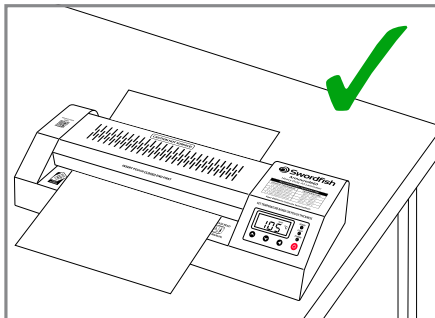
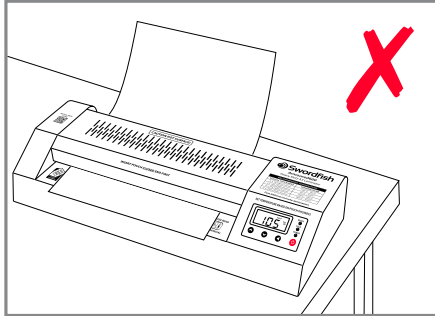

Operation

1 Connect the laminator to the 13Amp socket and turn the isolating switch on the rear of the machine to the "on" position. Press the red "Hot/Cold/Off" button on the front of the machine and the laminator will start to run.



CAUTION

Do not leave the laminator unattended during lamination.

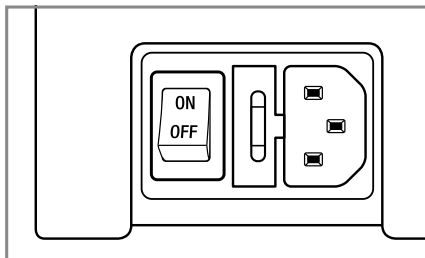

2 Set the desired temperature by pressing the "increase temperature" or "decrease temperature" buttons. When the chosen temperature is selected, "SET" will briefly appear at the top of the control panel screen. The word "READY" will flash. When the desired temperature has been reached, "READY" will cease flashing and the green ready light will illuminate.

Film thickness - microns (μ)	Temperature
2 x 75 μ (150 μ total)	100°C - 110°C
2 x 125 μ (250 μ total)	110°C - 120°C
2 x 175 μ (350 μ total)	130°C - 140°C
2 x 250 μ (500 μ total)	150°C - 160°C

3 Prepare the item to be laminated. Insert the item to be laminated into a pouch of the correct size and push it right into the sealed end of the pouch. The pouch could jam if the sealed end is not filled. Always insert the pouch into the laminator sealed end first.

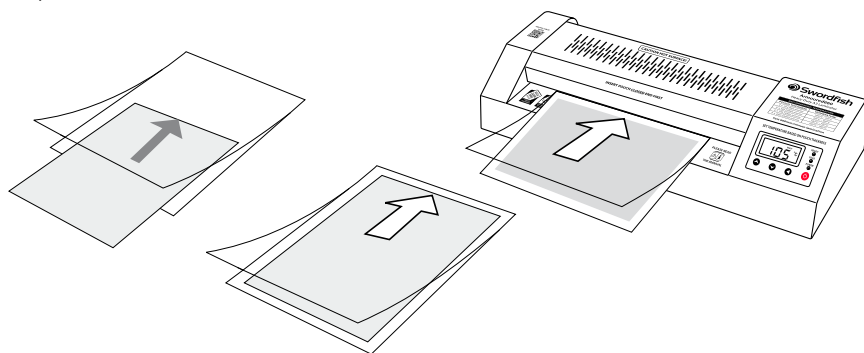

4 CAUTION

Lamination pouches are designed for use with full A4, A3, A2 etc. documents. If you wish to laminate non-standard items that do not support the pouch across its entire area, you must use a carrier or there is a real risk that the pouch will jam. Typical instances where a carrier must be used include:

- Multiple items within a single pouch
- Irregular shaped items
- Soft material such as newspaper, tissue, paper and fabrics
- Any item that leaves a border of more than a 3mm around its edges

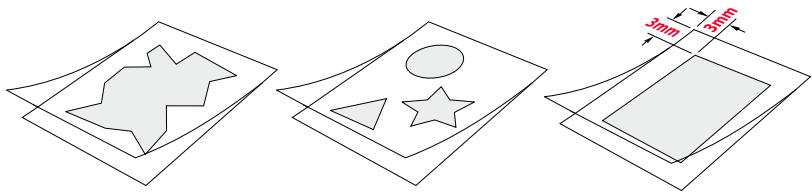

Failure to use a carrier in such cases could cause the pouch to jam. Carriers are available from your usual pouch supplier.

A cardboard carrier will absorb some of the heat so you may need to adjust the temperature settings accordingly.

Swordfish Armoured pouch carriers are made from PTFE-coated micro-fine woven fibreglass and will require little or no temperature adjustment.

Note that the maximum thickness of carrier + pouch + contents **MUST NOT EXCEED 1.0mm**.

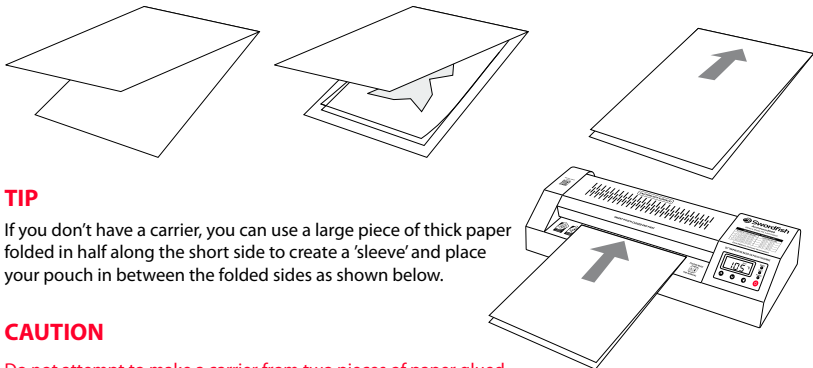

TIP

If you don't have a carrier, you can use a large piece of thick paper folded in half along the short side to create a 'sleeve' and place your pouch in between the folded sides as shown below.

CAUTION

Do not attempt to make a carrier from two pieces of paper glued or taped together - it will jam!

5 The laminated item will be transported out of the laminator automatically.



CAUTION

- Do not try to pull the pouch out by force. This may result in creases or curves in the laminated item and may damage the laminator.
- Remove the laminated item and lay it flat.
- The laminated item will be hot. Please handle it with care.

TIPS

If the correct settings are not chosen, the following lamination results may appear. Adjust the setting and try again.

White spots



Insufficient heat.
Increase the temperature a little.

Vertical spots

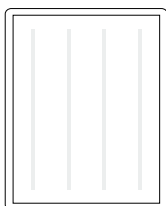

Insufficient heat.
Increase the temperature a little.

Clear & smooth

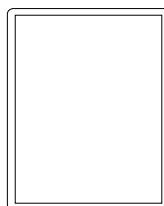

Setting is correct.

Horizontal ripples



Too hot!
Risk of jamming!
Decrease the temperature.

6



IMPORTANT

Never attempt to laminate the following items:

- Leaves or other organic material – moisture will be boiled out, potentially ruining the lamination, damaging the electronics in the machine and creating risk of electric shock.
- Wax crayon drawings – the wax will melt, destroying the drawing. Molten wax could be extruded into the machine and cause extensive damage.
- Documents printed on thermal paper or Polaroid-type instant photos – the images will disappear.
- Any item that is creased or which has irregular thickness – it could cause a jam or damage the rollers.
- Artwork assembled with glue or incorporating glitter-glue. The glue will melt and run into the laminator.
- Any item that is not heat-resistant.

7

Before turning off the machine, press the red “Hot/Cold/Off” button twice. The “cold” light will illuminate. Allow the laminator to run for 5 minutes before turning off the power. This will allow the rollers to cool evenly.



CAUTION

If the laminator is not going to be used for a long time, unplug it from the power socket.

Essential Information

- Never insert a pouch until the previous lamination has been removed from the machine. Failure to do so could cause a jam.
- The maximum capacity of this machine (pouch + contents) is 1.0mm.
- Should a miss-feed or jam occur, press the “reverse button” to eject the pouch.

Cold Lamination

The majority of lamination is done using pouches that are coated with adhesive that melts at high temperature. However, pouches coated with pressure-activated adhesive - so-called cold lamination pouches - are also available.

If you wish to use cold lamination pouches, turn on the red switch at the back of machine, and press the red “Hot/Cold/Off” button twice. The machine will then go into cold laminating mode. If the machine is still warm from previous hot lamination, “READY” will flash in the control panel while the rollers cool down.

Maintenance

We recommend that you regularly inspect the rollers for signs of pouch adhesive on the rollers and remove it with a soft cloth and alcohol (surgical spirit, rubbing alcohol or methylated spirit) when necessary. Do not use white spirit, petrol or any other solvents as they could damage the silicone rollers. Do not use sharp or abrasive tools when cleaning the rollers.

The inner faces of lamination pouches are coated with an adhesive that becomes molten at high temperatures. When a pouch is completely filled, this adhesive will usually be absorbed by the paper in the pouch. However, some adhesive may be squeezed out of the pouch and onto the rollers. If a pouch is not completely filled, a great deal of adhesive can be squeezed out onto the rollers.

IMPORTANT
 Sticky rollers can cause pouches to jam, so it is important to keep them clean.

To access the rollers, disconnect the machine from the electricity supply, allow it to cool, and then remove the top cover which is retained by two screws at the back. Use caution if the machine has been used recently – the top cover, the rollers and adjacent components may still be hot!

If you wish to clean the rollers while they are turning, first press the red “Hot/Cold/Off” button twice so that the machine goes into “cold lamination” mode and allow it to cool down. Remove the top cover only. Do not further dismantle the machine – risk of electric shock! Use extreme caution – take care that hair, clothing, jewellery, etc., does not become trapped by the rollers.

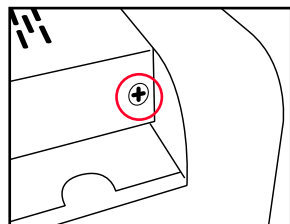

Phillips Screw x2 at the rear

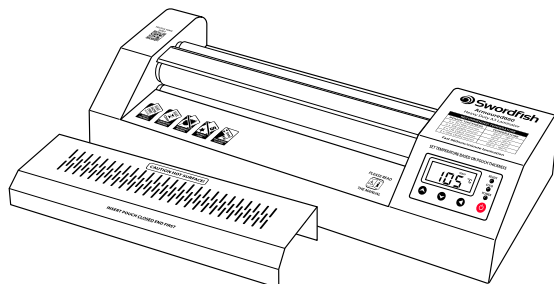

Cleaning

The outer case of the machine may be wiped clean with a moist cloth. Do not allow water to spill inside the laminator – risk of electric shock.



IMPORTANT

Do not use aerosol cleaners – or any other aerosol product – on, or near, this machine (or any other electrical appliance) as the propellant may be flammable.

Troubleshooting

The POWER light does not glow when the laminator is turned on.

Please ensure that the plug is firmly inserted into the power socket. Check that the isolating switch on the back of the machine is in the “on” position. Check that the red “Hot/Cold/Off” button on the control panel had been pressed the correct number of times (see P5, section 3).

White spots or cloudy areas appear on the lamination.

The temperature of the machine is too low – the adhesive inside the pouch has not melted completely. Either use a thinner pouch or raise the temperature – by small increments – until perfect results are achieved.

The lamination is creased, rippled or wavy.

The temperature of the laminator is too high. Decrease the temperature or use a thicker pouch.

The edges of the pouch are wavy.

If a number of smaller pouches have previously been laminated, the temperature of the rollers will be uneven. Allow the machine to run for a few minutes so that the temperature can stabilise.

If a pouch becomes jammed in the laminator.

Press and hold the “reverse” button. Pull the pouch gently, if necessary, but do not use excessive force as this could damage the laminator mechanism. If the jammed pouch cannot be removed, turn the laminator off immediately and contact your retailer for assistance. **Do not attempt to dismantle the laminator as this will invalidate your warranty and expose you to the risk of burn injuries and electric shock.**



To get the best results from your laminator and to avoid common lamination problems, scan this code with your smartphone.

Have you seen the rest of the Swordfish range?

Pencil Sharpeners



The Triple



Pointi



Trio

Paper Shredders



1000XC Plus



1200XXCD

Paper Trimmers

SlimLine
Series
A4, A3



Elite Series
A3/A2

To find out more information on the full range of products,
visit us at www.snopakebrands.com

